



MANIFOLD SYSTEMS

Manifold Systems • Manifold Changeover Cabinet • Manifold Components

COMPANY INTRODUCTION

GENTEC® Company Overview

Solutions for Life



Company Overview

Genstar Technologies is a global leader in Gas Flow Control Systems for the industrial, specialty gas and medical sectors. We pride ourselves in our ability to provide our customers with high quality, value-added products and services that go beyond the industry standards. As a result, we have a global network of thousands of satisfied customers in over 60 countries.

Our Team

Our highly educated team of engineers, salespeople, technicians, managers, and customer service personnel are dedicated to providing you with products with the highest quality, reliability and performance. We hold the highest standards to our manufacturing processes; our total process management maximizes our production efficiency while ensuring product quality.

We work closely with all of our customers to design products specific to your needs. This includes developing new products, redesigning existing products, and customizing configuration / packaging. It is our priority to foster a strong relationship with each and every customer.



Quality Assurance

All of our products are manufactured under stringent quality control. We are ISO 9001:2001, ISO13485, and API certified. Our products meet UL, CE, SEMI, and various international standards and certifications.

Manufacturing Capabilities

The manufacturing facility is equipped with CNC machining centers, electropolishing equipment, and precision automatic orbital welding systems, among other features, to ensure the production of the highest quality products.

Clean Room Facilities

Our class 10/100/1000 clean rooms are designed for Ultra High Purity (UHP) products. UHP products undergo precision machining, surface finishing, electro-polishing and passivation. All UHP products are cleaned by 18MΩ DI water in a cascade ultrasonic tank.

To ensure the highest UHP product quality, they are then vacuum-dried and double-bagged.



Manifold Systems

- 05. 5100 Series Manual Dual Cylinders Manifold Systems
- 06. 5200 Series Manual Single-Bank Manifold Systems
- 08. 5300 Series Manual Dual-Bank Manifold Systems
- 10. 5400 Series Semi-Automatic Manifold Systems
- 12. GM1E-A Series Dome-Bias Semi-Automatic Manifold Systems
- 14. GM1-A Series Dome-Bias Semi-Automatic Manifold Systems
- 16. GM2-A Series Dome-bias Fully-Automatic Analog Manifold Systems
- 18. GM2-D Series Dome-bias Fully-Automatic Digital Manifold Systems
- 20. GM2-T Series Dome-bias Fully-Automatic Touch Screen Manifold Systems
- 22. GM3-A Series Dome-bias Fully-Automatic Analog Hybrid Manifold Systems
- 24. GM3-T Series Dome-bias Fully-Automatic Touch Screen Hybrid Manifold Systems
- 26. 5500E Series Explosion-proof Fully-Automatic Manifold Systems
- 28. 5600 Series Semi-Automatic Manifold Systems for Liquid Vessel
- 29. 5700A Series Fully-Automatic Analog Manifold Systems for Liquid Vessel
- 30. 5700AD Series Fully-Automatic Digital Manifold Systems for Liquid Vessel



Manifold Changeover Cabinet

- 31. Manifold Changeover Cabinet



Manifold Components

- 33. Manifold Pipings & Header Extensions
- 34. Valves & Accessories, Manifold Components
- 35. Manifold Fittings
- 36. Pigtailes, Wall Mounts, Pipe Holders and Pipe Supports
- 37. Flashback Arrestors & Pressure Switches & Pressure Transmitter
- 38. Gas Filter, Filter Elements, Alarm Systems
- 39. Gas Terminal Box, Station Drops, Terminal Gas Control Panel
- 40. Flashback Arrestors, Quick Connectors & Flowmeters
- 41. Manifold Regulators
- 43. Station & Line Regulators
- 45. Warranty Information
- 47. Related Catalogs

AUTOMATIC MANIFOLD SYSTEMS

GENTEC® Product Advantage

Solutions for Life

1 Exhaust Port

- Easy for installation

2 Outlet

- 3/4" NPT for easy connection

3 Light And Control Buttons

- Status indicator
- Integral alarm buzzer
- Manual switch button for changeover

4 Pressure Gauge

- Multiple gauge unit option
- Work normally even in the event of power failure

5 Three-way Ball Valve

- Easy maintenance

6 Automatic Differential Pressure Type Switch Valve

- Patented design
- Double Solenoid valve control to initiate manifold switchover for uninterrupted gas supply

7 Control Circuit Board

- RS 485 communication and Dry Contact Output, can be integrated to a central monitoring system

8 Pressure Switches Pressure Transmitter

- 0~10V or 4~20 mA output
- Monitoring the outlet pressure and alarm for inlet pressure

9 Secondary Regulator

- High flow line regulator
- Per NFPA 99 requirements to allow for isolation and service of one while other is in use
- Available for on site repair
- Easy for maintenance

10 Ventilation Window

- Ventilation window on both sides of cabinet
- Well-ventilated to ensure safety

11 Primary Regulator

- Dome bias regulator technology
- Provide stable flow and durable
- Easy for maintenance

12 Relief Valve

- Relief pressures downstream of line regulators in order to prevent over pressurization.

13 Electrical Box

- NEMA 4 (IP66) electrical enclosure: Weatherproof protection against environmental elements.



AUTOMATIC MANIFOLD SYSTEMS

Solutions for Life

GENTEC® Product Advantage



MANIFOLD PURCHASE SPECIFICATIONS FORM

Solutions for Life

- 1 Application of the manifold system: Industrial Specialty Gas Others _____
- 2 Gas service: Oxygen Acetylene Propane Air Carbon Dioxide (CO₂)
 Inert Gases (Argon, Nitrogen, Helium) Others _____
- 3 Type of manifold system required: Manual Semi-Automatic Automatic
- 4 Outlet pressure required: (psi) _____
- 5 Outlet flow rate required: (SCFH) _____
- 6 Type of mounting: Wall Mount Floor Mount
- 7 Cylinder Spacing (Center to Center): 5" 10" 13" 18"
- 8 Number of cylinders required: Left Bank _____ Right Bank _____
- 9 Manifold system layout: _____

Series No Layout	5200 Series	5300/5400/5500/GM Series	5600/5700 Series
1 Standard Layout			
2 "L" shape Layout			
3 "U" shape Layout			
4 Crossover Layout			
5 Staggered Layout			

Manifolds

Cylinder

10 Accessories:

- | | | |
|--------------------------|-----------------|-----------|
| Pressure Switch | Model No. _____ | Qty _____ |
| Alarm System | Model No. _____ | Qty _____ |
| Gas Terminal (Pipeline) | Model No. _____ | Qty _____ |
| Gas Heater * | Model No. _____ | Qty _____ |
| Others | Model No. _____ | Qty _____ |

*: Optional 500 SCFH heater is available for CO₂ & N₂O gas service with withdrawal rates above 35 SCFH / cylinder.

Note: Please fill out the above form so GENTEC can recommend the most suitable manifold system for your application.
Please do not hesitate to contact us for more information.

5100 series manual dual cylinders manifold systems is a simple gas delivery system which provides a maximum of 2 cylinders in service at one time . This non-extendable system is suitable for maintenance and gas applications where only one cylinder is in service at any given time and a manual changeover is required.



Features

- Silver brazing on piping joints for maximum leak prevention
- Individual Header Valves
- Headers have been tested to withstand high cylinder pressure
- Wall mount installation only

Standard Construction

- 24" flexible high pressure stainless steel braided pigtails* with check valve, Rigid copper pigtails are standard when gas service is oxygen. Pigtails for acetylene models are equipped with dry flashback arrestor.
- For Acetylene or Fuel gas model, regulator outlet is equipped with a dry flashback arrestor (FA30PF) for additional safety.
- Gentec's high flow regulator series 155M-A.
- Carbon Dioxide manifold systems are provided with 155CG electric heating regulator. Siphon cylinder should not be used in the manifold system.

*: Refer to table on page 34 for pigtail information

Ordering Information

Gas Service	Series	Max. Inlet Pressure psi (bar)	Delivery Pressure psi (bar)	Max. Delivery Flow SCFH (m ³ /h)	Outlet Connection	Pigtail Specifications
Oxygen	5100X	2175 (150)	10~200 (0.7~14)	3500 (100)	3/4" NPT (M)	Pigtail, CGA540
	5100XH	3000 (207)	10~200 (0.7~14)	3500 (100)	3/4" NPT (M)	Pigtail, CGA540
Acetylene	5100Y	435 (30)	2~15 (0.14~1)	700 (20)	3/4" NPT (M)	Pigtail, CGA510
Propane	5100F	435 (30)	5~125 (0.35~8.6)	1050 (30)	3/4" NPT (M)	Pigtail, CGA510
Carbon Dioxide	5100C	3000 (207)	5~125 (0.35~8.6)	2100 (60)	3/4" NPT (M)	Pigtail, CGA320
Argon, Nitrogen, Helium	5100IN	2175 (150)	10~200 (0.7~14)	3500 (100)	3/4" NPT (M)	Pigtail, CGA580
	5100INH	3000 (207)	10~200 (0.7~14)	3500 (100)	3/4" NPT (M)	Pigtail, CGA580
Hydrogen	5100H	2175 (150)	10~200 (0.7~14)	10500 (300)	3/4" NPT (M)	Pigtail, CGA350
	5100HH	3000 (207)	10~200 (0.7~14)	10500 (300)	3/4" NPT (M)	Pigtail, CGA350

Please specify the "model number" when ordering.

For example: 5100X indicates a dual "oxygen" manifold system.

5200 SERIES

Manual Single-Bank Manifold Systems

Solutions for Life

5200 series manual single-bank manifold system is designed for a single source of gas supply from one cylinder bank. Although this system can be used as a main delivery system, it is typically used in industrial and medical applications as a high pressure emergency back-up system for liquid vessel or bulk systems.



Features

- Open-style manifold
- System can be designed for right or left bank
- Silver brazing on piping joints for maximum leak prevention
- System is designed to accommodate future expansion needs
- System is mounted with gas filters
- Pressure switch port is available
- Headers have been tested to withstand high cylinder pressure
- Wall or floor mount available

Standard Construction

- 24" flexible high pressure stainless steel braided pigtails* with check valve, Rigid copper pigtails are standard when gas service is oxygen. Pigtails for acetylene models are equipped with dry flashback arrestor.
- For Acetylene or Fuel gas model, regulator outlet is equipped with a dry flashback arrestor (FA30PF) for additional safety. As an option, hydraulic flashback arrestors are available for an additional charge.
- Gentec's high flow regulator series 155M-A.
- Carbon Dioxide manifold systems are provided with 155CG electric heating regulator. Siphon cylinder should not be used in the manifold system.

*:Refer to table on page 34 for pigtail information.

Specifications

Gas Service	Series	Max. Inlet Pressure psi (bar)	Delivery Pressure psi (bar)	Max. Delivery Flow SCFH (m ³ /h)	Outlet Connection	Pigtail Specifications
Oxygen	5200X	2175 (150)	10~200 (0.7~14)	3500 (100)	3/4" NPT (M)	Pigtail, CGA540
	5200XH	3000 (207)	10~200 (0.7~14)	3500 (100)	3/4" NPT (M)	Pigtail, CGA540
Acetylene	5200Y	435 (30)	2~15 (0.14~1)	700 (20)	3/4" NPT (M)	Pigtail, CGA510
Propane	5200F	435 (30)	5~125 (0.35~8.6)	1050 (30)	3/4" NPT (M)	Pigtail, CGA510
Carbon Dioxide	5200C	3000 (207)	5~125 (0.35~8.6)	2100 (60)	3/4" NPT (M)	Pigtail, CGA320
Argon, Nitrogen, Helium	5200IN	2175 (150)	10~200 (0.7~14)	3500 (100)	3/4" NPT (M)	Pigtail, CGA580
	5200INH	3000 (207)	10~200 (0.7~14)	3500 (100)	3/4" NPT (M)	Pigtail, CGA580
Air	5200Q	2175 (150)	10~200 (0.7~14)	3500 (100)	3/4" NPT (M)	Pigtail, CGA346
	5200QH	3000 (207)	10~200 (0.7~14)	3500 (100)	3/4" NPT (M)	Pigtail, CGA346
Hydrogen	5200H	2175 (150)	10~200 (0.7~14)	10500 (300)	3/4" NPT (M)	Pigtail, CGA350
	5200HH	3000 (207)	10~200 (0.7~14)	10500 (300)	3/4" NPT (M)	Pigtail, CGA350

Installation Dimensions

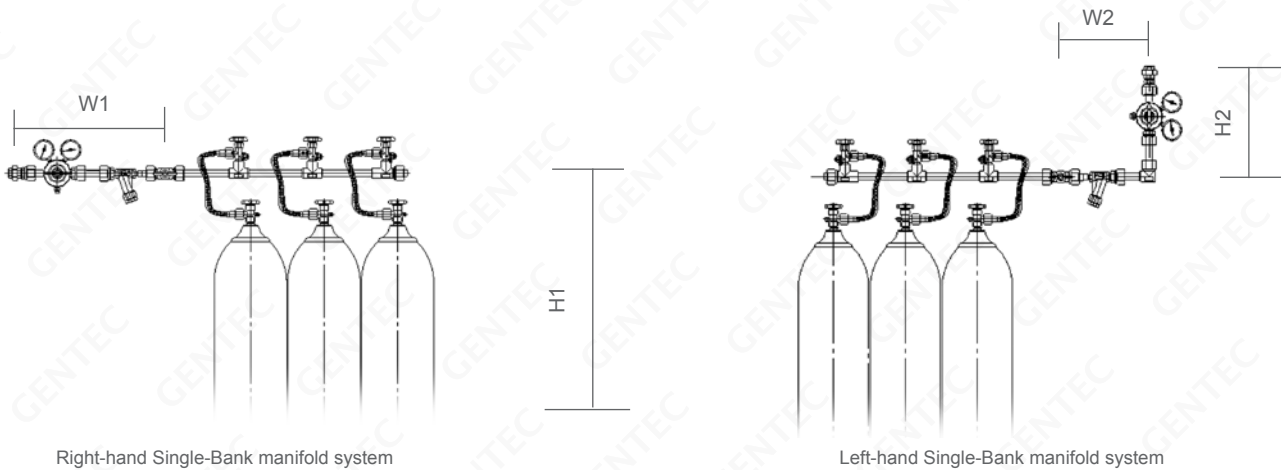

Gas Service	W1 in.(mm)	H1 in.(mm)	W2 in.(mm)	H2 in.(mm)
Oxygen, Air, Argon, Nitrogen, Helium	21.0 (534)	55.2 (1400)	12.3 (313)	14.6 (372)
Acetylene, Propane	27.8 (708)	51.2 (1300)	12.3 (313)	21.5 (546)
Carbon Dioxide	27.5 (698)	55.2 (1400)	18.8 (477)	14.6 (372)

Manifold System Layouts

Standard Layout	"L" shape Layout	Crossover Layout	Staggered Layout

Ordering Information

52	1	2	X	H	- 3	R	- 1
Series	Manifold System Layout	Cylinder Valve Spacing	Gas Service	Max. Inlet Pressure	Number of Cylinders	Direction of Manifold Piping	Type of Mounting
52	1: Standard layout 2: "L" Shape layout 4: Crossover layout 5: Staggered layout	1: 5" (127 mm) 2: 10" (254 mm) 3: 13" (330 mm) 4: 18" (457 mm)	X: Oxygen Y: Acetylene F: Propane C: Carbon Dioxide IN: Ar, He, N ₂ Q: Air H: Hydrogen	None: 2175 psi H: 3000 psi	1: One cylinder 2: Two cylinders 3: Three cylinders ...	L: left R: right <i>Note: Direction of piping (Right or Left) is indicated by facing the manifold.</i>	1: Wall mount 2: Floor mount

Example: **5212X-3R-1** indicates a 3 cylinder right-hand Single-bank oxygen manifold system.
Distance between each cylinder is 10" on standard horizontal layout.

5300 SERIES

Manual Dual-Bank Manifold Systems

Solutions for Life

5300 series manual dual-bank manifold system consists of a main gas delivery bank and a reserve bank of cylinders. When the primary cylinder bank is depleted, manually “turn off” the valve on the primary bank and open the valve on the reserve bank to reactivate gas flow. The changeover of this system needs to be operated manually.



Features

- Open-style manifold
- Silver brazing on piping joints for maximum leak prevention
- System is designed to accommodate future expansion needs
- System is mounted with gas filters
- Pressure switch port is available
- Headers have been tested to withstand high cylinder pressure
- Wall or floor mount available

Standard Construction

- 24" flexible high pressure stainless steel braided pigtails* with check valve, Rigid copper pigtails are standard when gas service is oxygen. Pigtails for acetylene models are equipped with dry flashback arrestor.
- For Acetylene or Fuel gas model, regulator outlet is equipped with a dry flashback arrestor (FA30PF) for additional safety. As an option, hydraulic flashback arrestors are available for an additional charge.
- Gentec's high flow regulator series 155M-A.
- Carbon Dioxide manifold systems are provided with 155CG electric heating regulator. Siphon cylinder should not be used in the manifold system.

*: Refer to table on page 34 for pigtail information

Specifications

Gas Service	Series	Max. Inlet Pressure psi (bar)	Delivery Pressure psi (bar)	Max. Delivery Flow SCFH (m ³ /h)	Outlet Connection	Pigtail Specifications
Oxygen	5300X	2175 (150)	10~200 (0.7~14)	3500 (100)	3/4" NPT (M)	Pigtail, CGA540
	5300XH	3000 (207)	10~200 (0.7~14)	3500 (100)	3/4" NPT (M)	Pigtail, CGA540
Acetylene	5300Y	435 (30)	2~15 (0.14~1)	700 (20)	3/4" NPT (M)	Pigtail, CGA510
Propane	5300F	435 (30)	5~125 (0.35~8.6)	1050 (30)	3/4" NPT (M)	Pigtail, CGA510
Carbon Dioxide	5300C	3000 (207)	5~125 (0.35~8.6)	2100 (60)	3/4" NPT (M)	Pigtail, CGA320
Argon, Nitrogen, Helium	5300IN	2175 (150)	10~200 (0.7~14)	3500 (100)	3/4" NPT (M)	Pigtail, CGA580
	5300INH	3000 (207)	10~200 (0.7~14)	3500 (100)	3/4" NPT (M)	Pigtail, CGA580
Air	5300Q	2175 (150)	10~200 (0.7~14)	3500 (100)	3/4" NPT (M)	Pigtail, CGA346
	5300QH	3000 (207)	10~200 (0.7~14)	3500 (100)	3/4" NPT (M)	Pigtail, CGA346
Hydrogen	5300H	2175 (150)	10~200 (0.7~14)	10500 (300)	3/4" NPT (M)	Pigtail, CGA350
	5300HH	3000 (207)	10~200 (0.7~14)	10500 (300)	3/4" NPT (M)	Pigtail, CGA350

Installation Dimensions

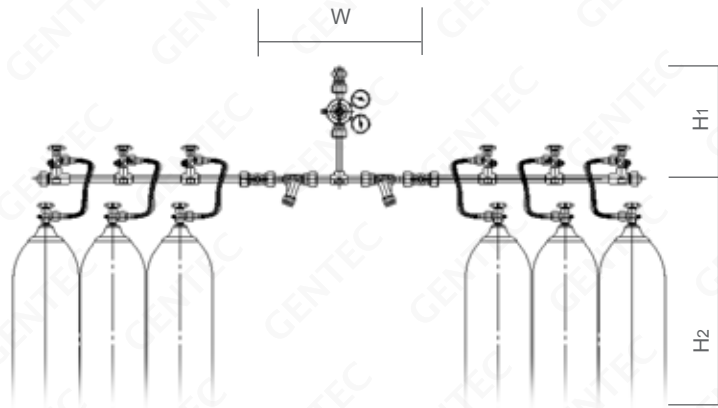

Gas Service	W in.(mm)	H1 in.(mm)	H2 in.(mm)
Oxygen, Air, Argon, Nitrogen, Helium	25.3 (642)	19.2 (488)	55.1 (1400)
Acetylene, Propane, Hydrogen	25.3 (642)	26.1 (662)	55.1 (1400)
Carbon Dioxide	25.3 (642)	25.7 (652)	55.1 (1400)

Manifold System Layouts

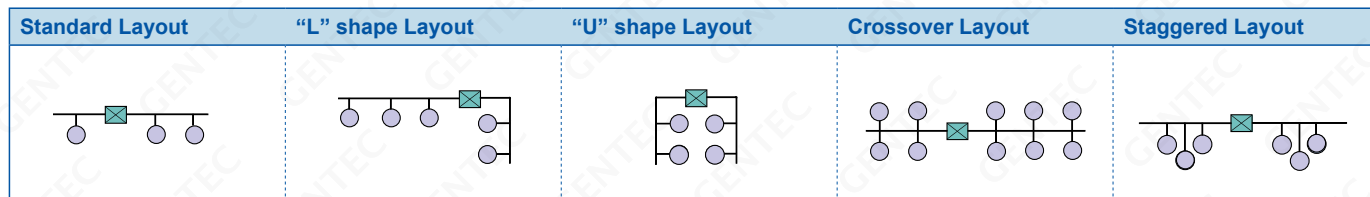

Ordering Information

53	1	2	X	H	- 5 x 5	- 1
Series	Manifold System Layout	Cylinder Valve Spacing	Gas Service	Max. Inlet Pressure	Number of Cylinders (left-hand / right-hand)	Type of Mounting
53	1: Standard layout 2: “L” Shape layout 3: “U” shape layout 4: Crossover layout 5: Staggered layout	1: 5” (127 mm) 2: 10” (254 mm) 3: 13” (330 mm) 4: 18” (457 mm)	X: Oxygen Y: Acetylene F: Propane C: Carbon Dioxide IN: Ar, He, N ₂ Q: Air H: Hydrogen	None: 2175 psi H: 3000 psi	1 x 2: One cylinder on the left, Two cylinders on the Right 5 x 5: Five cylinders on the left, Five cylinders on the Right ... Note: Direction of piping (Right or Left) is indicated by facing the manifold.	1: Wall mount 2: Floor mount

Example: **5312X-5x5-1** indicates a 5 x 5 cylinder dual-bank manifold system.
 Distance between two cylinders is 10” on standard horizontal layout.

5400 SERIES

Semi-Automatic Manifold Systems

Solutions for Life

5400 series semi-automatic manifold system is designed to provide an uninterrupted gas supply. It consists of a primary bank and a reserve bank of cylinders. When the pressure in the primary cylinder bank reduces to the pre-set value, the changeover takes place automatically to provide continuous supply of gas from the reserve bank. Upon changing the cylinders, the regulators on both banks need to be re-adjusted in order for the changeover to occur automatically next time. The secondary regulator in the main pipeline stabilizes the outlet gas flow.



Features

- Open-style manifold
- Secondary regulator for constant high flow delivery pressure to the pipeline
- Silver brazing on piping joints for maximum leak prevention
- System is designed to accommodate future expansion needs
- System is mounted with gas filters
- Unique changeover valve provides uninterrupted supply of gas from primary and reserve banks
- Pressure switch port is available
- Headers have been tested to withstand high cylinder pressure
- Wall or floor mount available

Standard Construction

- 24" flexible high pressure stainless steel braided pigtails* with check valve, Rigid copper pigtails are standard when gas service is oxygen. Pigtails for acetylene models are equipped with dry flashback arrestor.
- For Acetylene or Fuel gas model, regulator outlet is equipped with a dry flashback arrestor (FA30PF) for additional safety. As an option, hydraulic flashback arrestors are available for an additional charge.
- Gentec's high flow regulator series 155L (except for acetylene) & 155M-A.
- Carbon Dioxide manifold systems are provided with 155CG electric heating regulator. Siphon cylinder should not be used in the manifold system.

*: Refer to table on page 24 for pigtail information

Specifications

Gas Service	Series	Max. Inlet Pressure psi (bar)	Delivery Pressure psi (bar)	Max. Delivery Flow SCFH (m ³ /h)	Outlet Connection	Pigtail Specifications
Oxygen	5400X	2175 (150)	10~200 (0.7~14)	3150 (90)	3/4" NPT (M)	Pigtail, CGA540
	5400XH	3000 (207)	10~200 (0.7~14)	3150 (90)	3/4" NPT (M)	Pigtail, CGA540
Acetylene	5400Y	400 (28)	1.5~15 (0.1~1)	700 (20)	3/4" NPT (M)	Pigtail, CGA510
Propane	5400F	400 (28)	4.4~125 (0.3~8.5)	1050 (30)	3/4" NPT (M)	Pigtail, CGA510
Carbon Dioxide	5400C	3000 (207)	4.4~125 (0.3~8.5)	2100 (60)	3/4" NPT (M)	Pigtail, CGA320
Argon	5400IN	2175 (150)	10~200 (0.7~14)	1750 (50)	3/4" NPT (M)	Pigtail, CGA580
	5400INH	3000 (207)	10~200 (0.7~14)	1750 (50)	3/4" NPT (M)	Pigtail, CGA580
Helium	5400IN	2175 (150)	10~200 (0.7~14)	7000 (200)	3/4" NPT (M)	Pigtail, CGA580
	5400INH	3000 (207)	10~200 (0.7~14)	7000 (200)	3/4" NPT (M)	Pigtail, CGA580
Nitrogen	5400IN	2175 (150)	10~200 (0.7~14)	3500 (100)	3/4" NPT (M)	Pigtail, CGA580
	5400INH	3000 (207)	10~200 (0.7~14)	3500 (100)	3/4" NPT (M)	Pigtail, CGA580
Air	5400Q	2175 (150)	10~200 (0.7~14)	3500 (100)	3/4" NPT (M)	Pigtail, CGA346
	5400QH	3000 (207)	10~200 (0.7~14)	3500 (100)	3/4" NPT (M)	Pigtail, CGA346
Hydrogen	5400H	2175 (150)	10~200 (0.7~14)	10500 (300)	3/4" NPT (M)	Pigtail, CGA350
	5400HH	3000 (207)	10~200 (0.7~14)	10500 (300)	3/4" NPT (M)	Pigtail, CGA350

Installation Dimensions

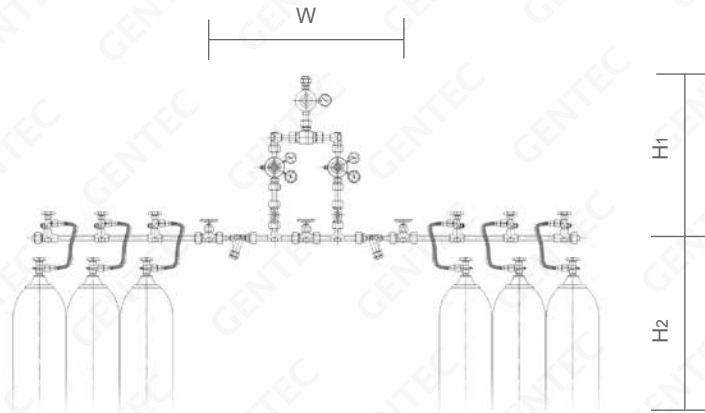

Gas Service	W in.(mm)	H1 in.(mm)	H2 in.(mm)
Oxygen, Air, Argon, Nitrogen, Helium	35.9 (912)	29.1 (739)	55.1 (1400)
Acetylene, Propane, Hydrogen	35.9 (912)	36.0 (913)	51.2 (1300)
Carbon Dioxide	35.9 (912)	29.1 (739)	55.1 (1400)

Manifold System Layouts

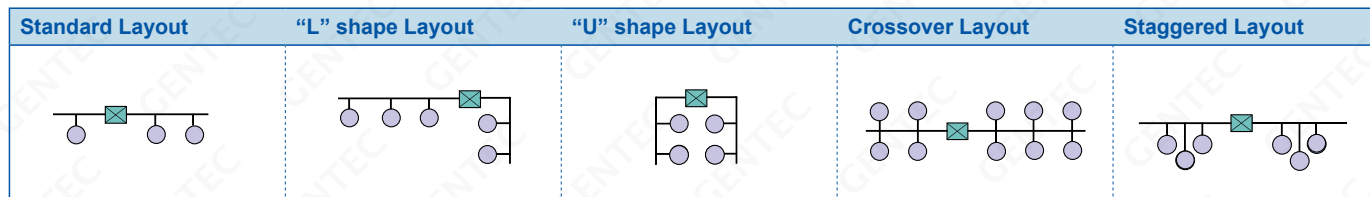

Ordering Information

54	1	2	X	H	- 5 x 5	- 1
Series	Manifold System Layout	Cylinder Valve Spacing	Gas Service	Max. Inlet Pressure	Number of Cylinders (left-hand / right-hand)	Type of Mounting
54	1: Standard layout 2: “L” Shape layout 3: “U” shape layout 4: Crossover layout 5: Staggered layout	1: 5” (127 mm) 2: 10” (254 mm) 3: 13” (330 mm) 4: 18” (457 mm)	X: Oxygen Y: Acetylene F: Propane C: Carbon Dioxide IN: Ar, He, N ₂ Q: Air H: Hydrogen	None: 2175 psi H: 3000 psi	1 x 2: One cylinder on the left, Two cylinders on the Right 5 x 5: Five cylinders on the left, Five cylinders on the Right ... Note: Direction of piping (Right or Left) is indicated by facing the manifold.	1: Wall mount 2: Floor mount

Example: **5412X-5x5-1** indicates a 5 x 5 cylinder semi-automatic manifold system.
 Distance between two cylinders is 10” on standard horizontal layout.

GM1E-A SERIES

Dome-bias Semi-Automatic Manifold Systems

Solutions for Life

GM1E-A series Dome-bias Semi-automatic Manifold System is designed to provide an uninterrupted gas supply. It consists of a primary bank and a reserve bank of cylinders. When the pressure in the primary cylinder bank reduces to the preset value, the changeover takes place automatically to provide continuous supply of gas from the reserve bank. The priority handle should be manually switched during cylinder change.



Features

Semi-automatic Changeover System

- Pressure gauge indicates gas source and outlet pressure
- Relief valve at outlet for protecting downstream piping
- Pressure switch port is available
- Mechanical dome-bias changeover design
- Priority Indicator valve
- Suitable for high flow system; rated for 120 m³/h (4200 SCFH)* to 170 m³/h (6000 SCFH)**

* When delivery pressure is 50 psi

** When delivery pressure is 180 psi

Pipeline

- Silver brazing on piping joints for maximum leak prevention
- System is designed to accommodate future expansion needs
- Optional external filter provides easy replacement of filter element
- Optional master shutoff valves
- Headers have been tested to withstand high cylinder pressure
- Wall or floor mount available

Standard Construction

- 24" flexible high pressure stainless steel braided pigtails* with check valve, Rigid copper pigtails are standard when gas service is oxygen. Pigtails for acetylene models are equipped with dry flashback arrestor.
- Carbon Dioxide manifold systems are provided with H900G electric heating regulator. Siphon cylinder should not be used in the manifold system.

Specifications

Gas Service	Series	Max. Inlet Pressure psi (bar)	Delivery Pressure psi (bar)	Max. Delivery Flow SCFH (m ³ /h)	Outlet Connection	Pigtail Specifications
Oxygen	GM1E-AL-O2	3000 (207)	100~145 (7~10)	3500 (100)	3/4" NPT (F)	Pigtail, CGA540
	GM1E-AM-O2	3000 (207)	170~230 (12~16)	4200 (120)	3/4" NPT (F)	Pigtail, CGA540
	GM1E-AH-O2	3000 (207)	200~270 (14~18)	6000 (170)	3/4" NPT (F)	Pigtail, CGA540
Air	GM1E-AL-AIR	3000 (207)	100~145 (7~10)	3500 (100)	3/4" NPT (F)	Pigtail, CGA346
	GM1E-AM-AIR	3000 (207)	170~230 (12~16)	4200 (120)	3/4" NPT (F)	Pigtail, CGA346
	GM1E-AH-AIR	3000 (207)	200~270 (14~18)	6000 (170)	3/4" NPT (F)	Pigtail, CGA346
Nitrous Oxide	GM1E-AL-N2O	3000 (207)	100~145 (7~10)	1060 (30)	3/4" NPT (F)	Pigtail, CGA326
	GM1E-AM-N2O	3000 (207)	170~230 (12~16)	1060 (30)	3/4" NPT (F)	Pigtail, CGA326
	GM1E-AH-N2O	3000 (207)	200~270 (14~18)	1060 (30)	3/4" NPT (F)	Pigtail, CGA326
Carbon Dioxide	GM1E-AL-CO2	2175 (150)	100~145 (7~10)	1060 (30)	3/4" NPT (F)	Pigtail, CGA320
	GM1E-AM-CO2	2175 (150)	170~230 (12~16)	1060 (30)	3/4" NPT (F)	Pigtail, CGA320
	GM1E-AH-CO2	2175 (150)	200~270 (14~18)	1060 (30)	3/4" NPT (F)	Pigtail, CGA320
Argon, Helium, Nitrogen	GM0E-AL-IN	3000 (207)	100~145 (7~10)	3500 (100)	3/4" NPT (F)	Pigtail, CGA580
	GM1E-AM-IN	3000 (207)	170~230 (12~16)	4200 (120)	3/4" NPT (F)	Pigtail, CGA580
	GM1E-AH-IN	3000 (207)	200~270 (14~18)	6000 (170)	3/4" NPT (F)	Pigtail, CGA580

GM1E-A SERIES

Solutions for Life

Dome-bias Semi-Automatic Manifold Systems

Installation Dimensions

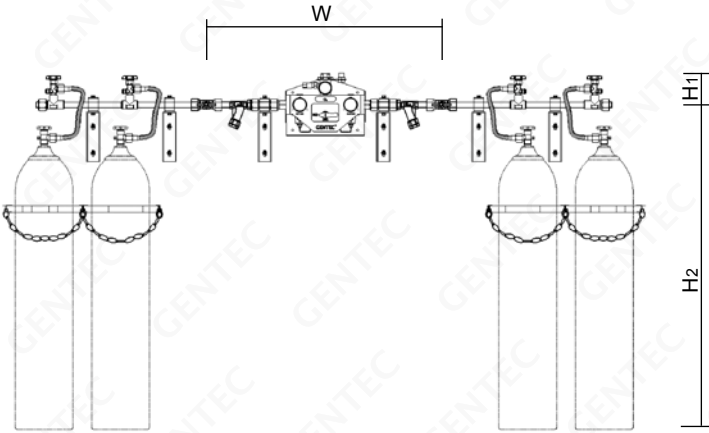

Gas Service	W in.(mm)	H1 in.(mm)	H2 in.(mm)
Oxygen, Air, Nitrous Oxide, Argon, Nitrogen, Helium	41.3 (1050)	15.8 (400)	55.1 (1400)
Carbon Dioxide	56.3 (1430)	15.8 (400)	55.1 (1400)

Manifold System Layouts

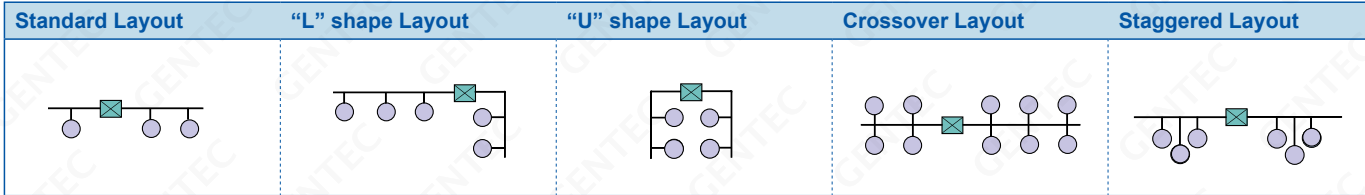

Ordering Information

GM1E-A	L	- O2	- U	- (5L x 5R	- S	2)
Series	Delivery Pressure	Gas Service	Standard Code	Number of Cylinders (left-hand / right-hand)	Manifold System Layout	Cylinder Valve Spacing
GM1E-A	USA (ISO) L: 55 psi (5 bar) M: 100 psi (8 bar) H: 185 psi (10 bar)	O2: Oxygen AIR: Air N2O: Nitrous Oxide CO2: Carbon Dioxide IN: Ar, He, N ₂	U: USA Standard E: ISO Standard	1L x 2R: One cylinder on the left, Two cylinders on the Right 5L x 5R: Five cylinders on the left, Five cylinders on the Right ...	S: Standard layout L: "L" Shape layout U: "U" shape layout D: Crossover layout X: Staggered layout	1: 5" (127 mm) 2: 10" (254 mm) 3: 13" (330 mm) 4: 18" (457 mm)

Note: Direction of piping (Right or Left) is indicated by facing the manifold.

Example: **GM1E-AL-O2-U-(5Lx5R-S2)** indicates a 5*5 oxygen cylinder semi-automatic manifold system. Distance between two cylinders is 10" on standard horizontal layout. NFPA99 color code (USA)
GM1E-AL-O2-U-(0x0) indicates an oxygen changeover system with filters and master shutoff valves. NFPA99 color code (USA)
GM1E-AL-O2-U indicates an oxygen changeover system only. NFPA99 color code (USA)

GM1-A SERIES

Dome-bias Semi-Automatic Manifold Systems

Solutions for Life

GM1-A series dome-bias semi-automatic manifold system is designed to provide an uninterrupted gas supply. It consists of a primary bank and a reserve bank of cylinders. When the pressure in the primary cylinder bank reduces to the preset value, the changeover takes place automatically to provide continuous supply of gas from the reserve bank. The priority handle should be manually switched during cylinder change.



Features

Semi-automatic Changeover System

- Fully enclosed, dust-proof metal cabinet
- Pressure gauge indicates gas source and outlet pressure
- Secondary regulator for consistent pressure and flow delivery to the pipeline
- Relief valve at outlet for protecting downstream piping
- Pressure switch port is available
- Mechanical dome-bias changeover design
- Priority Indicator valve
- Suitable for high flow system; rated for 120 m³/h (4200 SCFH)* to 170 m³/h (6000 SCFH)**

* When delivery pressure is 50 psi

** When delivery pressure is 180 psi

Pipeline

- Silver brazing on piping joints for maximum leak prevention
- System is designed to accommodate future expansion needs
- Optional external filter provides easy replacement of filter element
- Optional master shutoff valves
- Headers have been tested to withstand high cylinder pressure
- Wall or floor mount available

Specifications

Gas Service	Series	Max. Inlet Pressure psi (bar)	Delivery Pressure psi (bar)	Max. Delivery Flow SCFH (m ³ /h)	Outlet Connection	Pigtail Specifications
Oxygen	GM1-AL-O2	3000 (207)	50~65 (3.4~4.5)	3500 (100)	Rc 3/4"Union	Pigtail, CGA540
	GM1-AM-O2	3000 (207)	100~125 (6.9~8.6)	4200 (120)	Rc 3/4"Union	Pigtail, CGA540
	GM1-AH-O2	3000 (207)	155~185 (10.7~12.8)	6000 (170)	Rc 3/4"Union	Pigtail, CGA540
Air	GM1-AL-AIR	3000 (207)	50~65 (3.4~4.5)	3500 (100)	Rc 3/4"Union	Pigtail, CGA346
	GM1-AM-AIR	3000 (207)	100~125 (6.9~8.6)	4200 (120)	Rc 3/4"Union	Pigtail, CGA346
	GM1-AH-AIR	3000 (207)	155~185 (10.7~12.8)	6000 (170)	Rc 3/4"Union	Pigtail, CGA346
Nitrous Oxide	GM1-AL-N2O	3000 (207)	50~65 (3.4~4.5)	1060 (30)	Rc 3/4"Union	Pigtail, CGA326
	GM1-AM-N2O	3000 (207)	100~125 (6.9~8.6)	1060 (30)	Rc 3/4"Union	Pigtail, CGA326
	GM1-AH-N2O	3000 (207)	155~185 (10.7~12.8)	1060 (30)	Rc 3/4"Union	Pigtail, CGA326
Carbon Dioxide	GM1-AL-CO2	2175 (150)	50~65 (3.4~4.5)	1060 (30)	Rc 3/4"Union	Pigtail, CGA320
	GM1-AM-CO2	2175 (150)	100~125 (6.9~8.6)	1060 (30)	Rc 3/4"Union	Pigtail, CGA320
	GM1-AH-CO2	2175 (150)	155~185 (10.7~12.8)	1060 (30)	Rc 3/4"Union	Pigtail, CGA320
Argon, Helium, Nitrogen	GM1-AL-IN	3000 (207)	50~65 (3.4~4.5)	3500 (100)	Rc 3/4"Union	Pigtail, CGA580
	GM1-AM-IN	3000 (207)	100~125 (6.9~8.6)	4200 (120)	Rc 3/4"Union	Pigtail, CGA580
	GM1-AH-IN	3000 (207)	155~185 (10.7~12.8)	6000 (170)	Rc 3/4"Union	Pigtail, CGA580
Acetylene	GM1-AL-C2H2	435 (30)	1.5~15 psi (0.1~1 bar)	700 (20)	Rc 3/4"Union	Pigtail, CGA510
Propane	GM1-AM-C3H8	435 (30)	100~125 (6.9~8.6)	1060 (30)	Rc 3/4"Union	Pigtail, CGA510
Hydrogen	GM1-AH-H2	3000 (207)	155~185 (10.7~12.8)	30500 (300)	Rc 3/4"Union	Pigtail, CGA350

GM1-A SERIES

Dome-bias Semi-Automatic Manifold Systems

Solutions for Life

Installation Dimensions

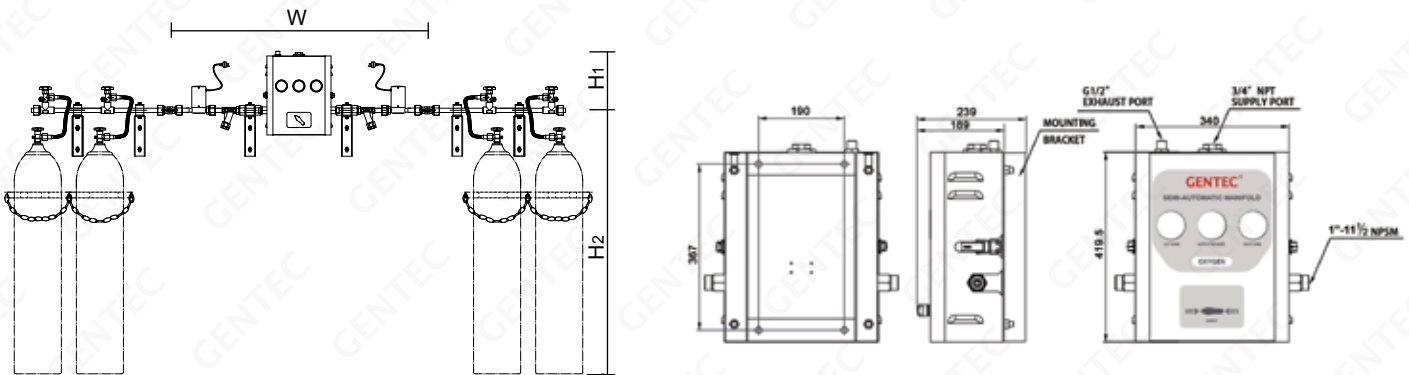

Gas Service	W in.(mm)	H1 in.(mm)	H2 in.(mm)
Oxygen, Air, Nitrous Oxide, Argon, Nitrogen, Helium	41.3 (1050)	15.8 (400)	55.1 (1400)
Acetylene, Propane, Hydrogen	41.3 (1050)	21.7 (550)	55.1 (1400)
Carbon Dioxide	56.3 (1430)	15.8 (400)	55.1 (1400)

Manifold System Layouts

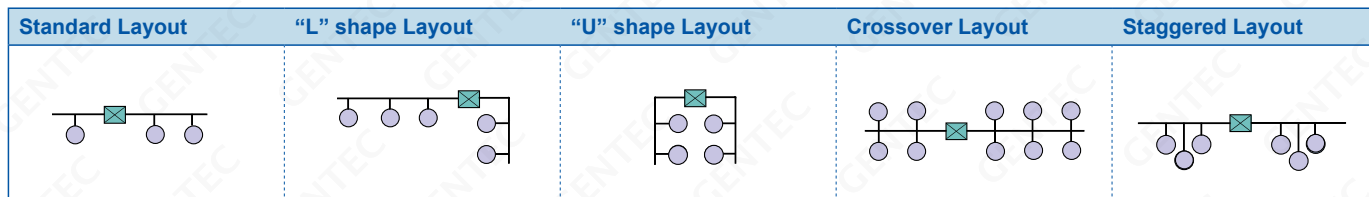

Ordering Information

Series	Delivery Pressure	Gas Service	Standard Code	Number of Cylinders (Left-hand x Right-hand)	Manifold System Layout	Cylinder Valve Spacing
GM1-A	USA (ISO) L: 55 psi (5 bar) M: 100 psi (8 bar) H: 185 psi (10 bar)	O2: Oxygen AIR: Air N2O: Nitrous Oxide CO2: Carbon Dioxide IN: Ar, He, N ₂ C2H2: Acetylene C3H8: Propane H2: Hydrogen	U: USA Standard E: ISO Standard	1L x 2R: One cylinder on the left, Two cylinders on the Right 5L x 5R: Five cylinders on the left, Five cylinders on the Right ...	S: Standard layout L: "L" Shape layout U: "U" shape layout D: Crossover layout X: Staggered layout	1: 5" (127 mm) 2: 10" (254 mm) 3: 13" (330 mm) 4: 18" (457 mm)

Note: Direction of piping (Right or Left) is indicated by facing the manifold.

Example: **GM1-AL-O2-U-(5Lx5R-S2)** indicates a 5*5 oxygen cylinder semi-automatic manifold system. Distance between two cylinders is 10" on standard horizontal layout. NFPA99 color code (USA)

GM1-AL-O2-U-(0x0) indicates an oxygen changeover system with filters and master shutoff valves. NFPA99 color code (USA)

GM1-AL-O2-U indicates an oxygen changeover system only. NFPA99 color code (USA)

GM2-A SERIES

Dome-bias Fully-Automatic Analog Manifold Systems

Solutions for Life

GM2-A series dome-bias fully-automatic analog manifold systems is designed to provide an uninterrupted gas supply without any manual adjustments. This system automatically switches over when the primary cylinder bank is depleted. Even in case of a power failure, the system continues to supply gas without interruption. The system is designed to meet the latest edition of NFPA 99 and CGA standards.



Features

Semi-automatic Changeover System

- Fully enclosed, tamper-resistant metal cabinet
- Light indicators provide system status
- Systems for fuel gas come with an anti-explosive device
- External filter facilitates replacement of filtration elements

Pipeline

- Silver brazing on piping joints for maximum leak prevention
- System is designed to accommodate future expansion needs
- System is mounted with gas filters
- Pressure switch port available
- Headers have been tested to withstand high cylinder pressure
- Wall or floor mount available

Standard Construction

- 24" flexible high pressure stainless steel braided pigtails* with check valve, Rigid copper pigtails are standard when gas service is oxygen. Pigtails for acetylene models are equipped with dry flashback arrestor.
- Carbon Dioxide manifold systems are provided with H900G electric heating regulator. Siphon cylinder should not be used in the manifold system.

Specifications

Gas Service	Series	Max. Inlet Pressure psi (bar)	Delivery Pressure psi (bar)	Max. Delivery Flow SCFH (m ³ /h)	Outlet Connection	Pigtail Specifications
Oxygen	GM2-AL-O2	3000 (207)	50~65 (3.4~4.5)	3500 (100)	Rc 3/4"Union	Pigtail, CGA540
	GM2-AM-O2	3000 (207)	100~125 (6.9~8.6)	4200 (120)	Rc 3/4"Union	Pigtail, CGA540
	GM2-AH-O2	3000 (207)	155~185 (10.7~12.8)	6000 (170)	Rc 3/4"Union	Pigtail, CGA540
Air	GM2-AL-AIR	3000 (207)	50~65 (3.4~4.5)	3500 (100)	Rc 3/4"Union	Pigtail, CGA346
	GM2-AM-AIR	3000 (207)	100~125 (6.9~8.6)	4200 (120)	Rc 3/4"Union	Pigtail, CGA346
	GM2-AH-AIR	3000 (207)	155~185 (10.7~12.8)	6000 (170)	Rc 3/4"Union	Pigtail, CGA346
Nitrous Oxide	GM2-AL-N2O	3000 (207)	50~65 (3.4~4.5)	1060 (30)	Rc 3/4"Union	Pigtail, CGA326
	GM2-AM-N2O	3000 (207)	100~125 (6.9~8.6)	1060 (30)	Rc 3/4"Union	Pigtail, CGA326
	GM2-AH-N2O	3000 (207)	155~185 (10.7~12.8)	1060 (30)	Rc 3/4"Union	Pigtail, CGA326
Carbon Dioxide	GM2-AL-CO2	2175 (150)	50~65 (3.4~4.5)	1060 (30)	Rc 3/4"Union	Pigtail, CGA320
	GM2-AM-CO2	2175 (150)	100~125 (6.9~8.6)	1060 (30)	Rc 3/4"Union	Pigtail, CGA320
	GM2-AH-CO2	2175 (150)	155~185 (10.7~12.8)	1060 (30)	Rc 3/4"Union	Pigtail, CGA320
Argon, Helium, Nitrogen	GM2-AL-IN	3000 (207)	50~65 (3.4~4.5)	3500 (100)	Rc 3/4"Union	Pigtail, CGA580
	GM2-AM-IN	3000 (207)	100~125 (6.9~8.6)	4200 (120)	Rc 3/4"Union	Pigtail, CGA580
	GM2-AH-IN	3000 (207)	155~185 (10.7~12.8)	6000 (170)	Rc 3/4"Union	Pigtail, CGA580

Installation Dimensions

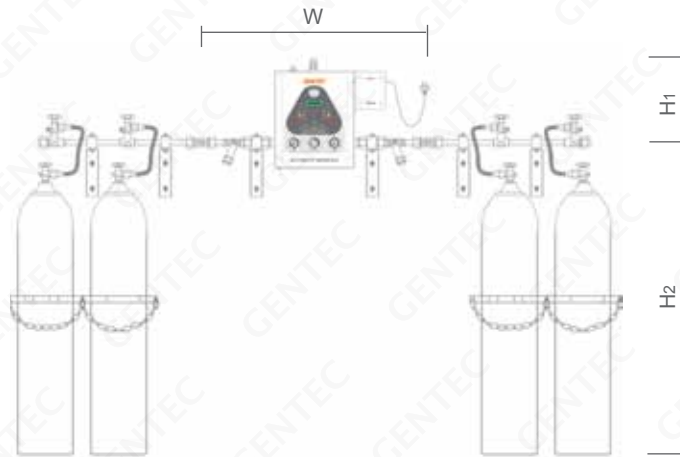

Gas Service	W in.(mm)	H1 in.(mm)	H2 in.(mm)
Oxygen, Air, Nitrous Oxide, Argon, Nitrogen, Helium	44.1 (1120)	15.8 (400)	55.1 (1400)
Carbon Dioxide	56.3 (1430)	15.8 (400)	55.1 (1400)

Manifold System Layouts

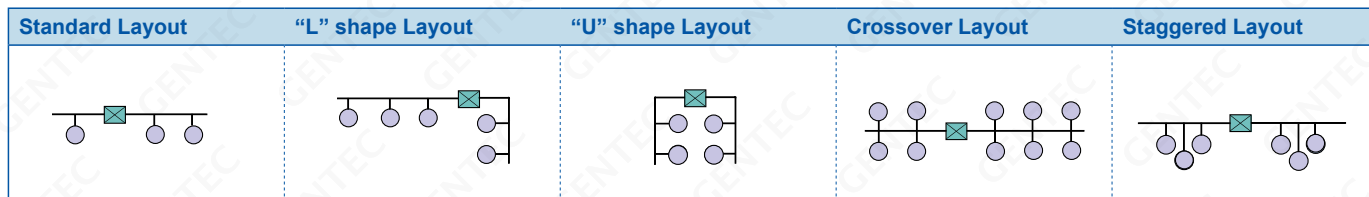

Ordering Information

GM2-A	L	- O2	- U	- (5L x 5R	- S	2)
Series	Delivery Pressure	Gas Service	Standard Code	Number of Cylinders (left-hand / right-hand)	Manifold System Layout	Cylinder Valve Spacing
GM2-A	USA (ISO) L: 55 psi (5 bar) M: 100 psi (8 bar) H: 185 psi (10 bar)	O2: Oxygen AIR: Air N2O: Nitrous Oxide CO2: Carbon Dioxide IN: Ar, He, N ₂	U: USA Standard E: ISO Standard	1L x 2R: One cylinder on the left, Two cylinders on the Right 5L x 5R: Five cylinders on the left, Five cylinders on the Right ...	S: Standard layout L: "L" Shape layout U: "U" shape layout D: Crossover layout X: Staggered layout	1: 5" (127 mm) 2: 10" (254 mm) 3: 13" (330 mm) 4: 18" (457 mm)
				Note: Direction of piping (Right or Left) is indicated by facing the manifold.		

Example: **GM2-AL-O2-U-(5Lx5R-S2)** indicates a 5*5 oxygen cylinder fully-automatic analog manifold system.

Distance between two cylinders is 10" on standard horizontal layout. NFPA99 color code (USA)

GM2-AL-O2-U-(0x0) indicates an oxygen changeover system with filters and master shutoff valves. NFPA99 color code (USA)

GM2-AL-O2-U indicates an oxygen changeover system only. NFPA99 color code (USA)

GM2-D SERIES

Dome-bias Fully-Automatic Digital Manifold Systems

Solutions for Life

GM2-D series dome-bias fully-automatic digital manifold systems is designed to provide an uninterrupted gas supply. The fully automatic digital manifold system monitors cylinder bank pressure electronically, automatically changes over to secondary bank when the primary cylinder bank is depleted, and eliminates the need to manually set a priority side. In case of power failure, the system continues to supply gas without interruption. Using our second generation pressure differential switchover valve and newly designed manifold regulators boosts the flowrate and reliability of the system.



Features

Automatic Changeover Cabinet

- Fully enclosed, tamper-resistant metal cabinet
- On-site Display: Indicator lights of system status, gauge pressures, visual remote alarm box provide system status; digital display of pressure; with changeover alarm function
- Pressure switch control
- External filter facilitates replacement of filtration elements
- Patent pending changeover technology

Pipeline

- Silver brazing on piping joints for maximum leak prevention
- System is designed to accommodate future expansion needs
- System is mounted with gas filters
- Pressure switch port available
- Headers have been tested to withstand high cylinder pressure
- Wall or floor mount available

Standard Construction

- 24" flexible high pressure stainless steel braided pigtails with check valve, Rigid copper pigtails are standard when gas service is oxygen. Pigtails for acetylene models are equipped with dry flashback arrestor.
- Carbon Dioxide manifold systems are provided with H900DG electric heating regulator. Siphon cylinder should not be used in the manifold system.

Specifications

Gas Service	Series	Max. Inlet Pressure psi (bar)	Delivery Pressure psi (bar)	Max. Delivery Flow SCFH (m ³ /h)	Outlet Connection	Pigtail Specifications
Oxygen	GM2-DL-O2	3000 (207)	50~65 (3.4~4.5)	3500 (100)	Rc 3/4"Union	Pigtail, CGA540
	GM2-DM-O2	3000 (207)	100~125 (6.9~8.6)	4200 (120)	Rc 3/4"Union	Pigtail, CGA540
	GM2-DH-O2	3000 (207)	155~185 (10.7~12.8)	6000 (170)	Rc 3/4"Union	Pigtail, CGA540
Air	GM2-DL-AIR	3000 (207)	50~65 (3.4~4.5)	3500 (100)	Rc 3/4"Union	Pigtail, CGA346
	GM2-DM-AIR	3000 (207)	100~125 (6.9~8.6)	4200 (120)	Rc 3/4"Union	Pigtail, CGA346
	GM2-DH-AIR	3000 (207)	155~185 (10.7~12.8)	6000 (170)	Rc 3/4"Union	Pigtail, CGA346
Nitrous Oxide	GM2-DL-N2O	3000 (207)	50~65 (3.4~4.5)	1060 (30)	Rc 3/4"Union	Pigtail, CGA326
	GM2-DM-N2O	3000 (207)	100~125 (6.9~8.6)	1060 (30)	Rc 3/4"Union	Pigtail, CGA326
	GM2-DH-N2O	3000 (207)	155~185 (10.7~12.8)	1060 (30)	Rc 3/4"Union	Pigtail, CGA326
Carbon Dioxide	GM2-DL-CO2	2175 (150)	50~65 (3.4~4.5)	1060 (30)	Rc 3/4"Union	Pigtail, CGA320
	GM2-DM-CO2	2175 (150)	100~125 (6.9~8.6)	1060 (30)	Rc 3/4"Union	Pigtail, CGA320
	GM2-DH-CO2	2175 (150)	155~185 (10.7~12.8)	1060 (30)	Rc 3/4"Union	Pigtail, CGA320
Argon, Helium, Nitrogen	GM2-DL-IN	3000 (207)	50~65 (3.4~4.5)	3500 (100)	Rc 3/4"Union	Pigtail, CGA580
	GM2-DM-IN	3000 (207)	100~125 (6.9~8.6)	4200 (120)	Rc 3/4"Union	Pigtail, CGA580
	GM2-DH-IN	3000 (207)	155~185 (10.7~12.8)	6000 (170)	Rc 3/4"Union	Pigtail, CGA580

Installation Dimensions

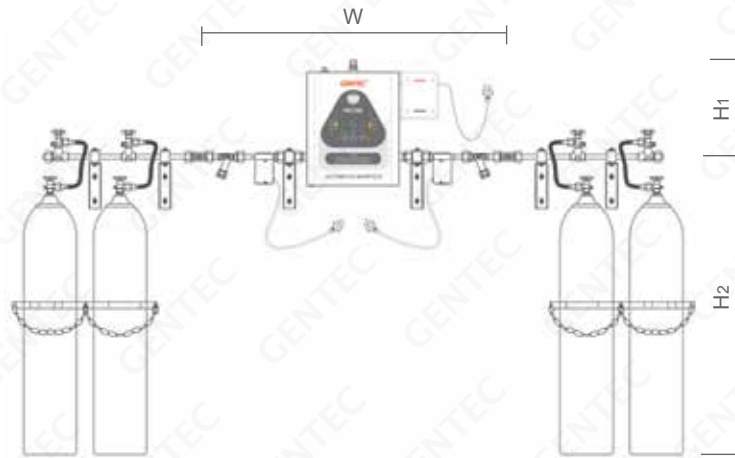

Gas Service	W in.(mm)	H1 in.(mm)	H2 in.(mm)
Oxygen, Air, Nitrous Oxide, Argon, Nitrogen, Helium	44.1 (1120)	15.8 (400)	55.1 (1400)
Carbon Dioxide	56.3 (1430)	15.8 (400)	55.1 (1400)

Manifold System Layouts

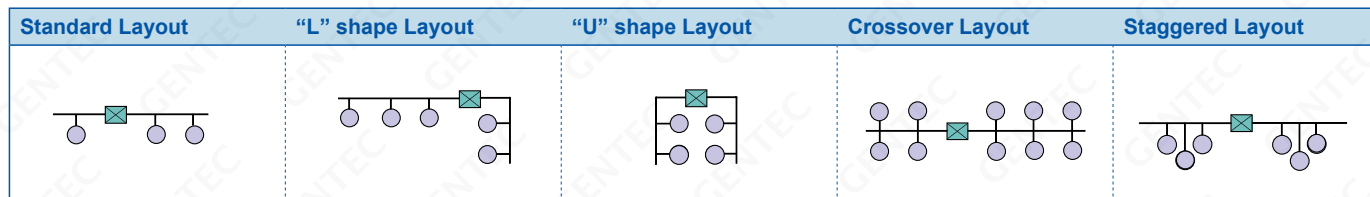

Ordering Information

GM2-D	L	- O2	- U	- (5L x 5R	- S	2)
Series	Delivery Pressure	Gas Service	Standard Code	Number of Cylinders (left-hand / right-hand)	Manifold System Layout	Cylinder Valve Spacing
GM2-D	USA (ISO) L: 55 psi (5 bar) M: 100 psi (8 bar) H: 185 psi (10 bar)	O2: Oxygen AIR: Air N2O: Nitrous Oxide CO2: Carbon Dioxide IN: Ar, He, N ₂	U: USA Standard E: ISO Standard	1L x 2R: One cylinder on the left, Two cylinders on the Right 5L x 5R: Five cylinders on the left, Five cylinders on the Right ...	S: Standard layout L: "L" Shape layout U: "U" shape layout D: Crossover layout X: Staggered layout	1: 5" (127 mm) 2: 10" (254 mm) 3: 13" (330 mm) 4: 18" (457 mm)
<p>Note: Direction of piping (Right or Left) is indicated by facing the manifold.</p>						

Example: **GM2-DL-O2-U-(5Lx5R-S2)** indicates a 5*5 oxygen cylinder fully-automatic digital manifold system.

Distance between two cylinders is 10" on standard horizontal layout. NFPA99 color code (USA)

GM2-DL-O2-U-(0x0) indicates an oxygen changeover system with filters and master shutoff valves. NFPA99 color code (USA)

GM2-DL-O2-U indicates an oxygen changeover system only. NFPA99 color code (USA)

GM2-T SERIES

Dome-bias Fully-Automatic Touch Screen Manifold Systems

Solutions for Life

GM2-T Series dome-bias fully-automatic touch screen manifold systems is designed to provide an uninterrupted gas supply without any manual adjustments. This system automatically switches over when the primary cylinder bank is depleted. Even in case of a power failure, the system continues to supply gas without interruption. The system is designed to meet the latest edition of NFPA 99 and CGA standards.



Features

Automatic Changeover Cabinet

- Fully enclosed, dust-proof metal cabinet
- Automatic Switchover when pressure is below preset limit
- Touch Screen LCD Display for easy control and monitoring
- Automatically generated alarm table
- Built-in network connection, can be integrated to the network system for real-time monitoring with RS-485 or ethernet cable
- Suitable for high flow system; rated for 120 m³/h (4200 SCFH)* to 170m³/h (6000 SCFH)**

* When delivery pressure is 50 psi

** When delivery pressure is 180 psi

Pipeline

- Silver brazing on piping joints for maximum leak prevention
- System is designed to accommodate future expansion needs
- System is mounted with gas filters
- Pressure switch port available
- Headers have been tested to withstand high cylinder pressure
- Wall or floor mount available

Standard Construction

- 24" flexible high pressure stainless steel braided pigtails with check valve, Rigid copper pigtails are standard when gas service is oxygen.
- Carbon Dioxide manifold systems are provided with H900DG electric heating regulator. Siphon cylinder should not be used in the manifold system.

Specifications

Gas Service	Series	Max. Inlet Pressure psi (bar)	Delivery Pressure psi (bar)	Max. Delivery Flow SCFH (m ³ /h)	Outlet Connection	Pigtail Specifications
Oxygen	GM2-TL-O2	3000 (207)	50~65 (3.4~4.5)	3500 (100)	Rc 3/4"Union	Pigtail, CGA540
	GM2-TM-O2	3000 (207)	100~125 (6.9~8.6)	4200 (120)	Rc 3/4"Union	Pigtail, CGA540
	GM2-TH-O2	3000 (207)	155~185 (10.7~12.8)	6000 (170)	Rc 3/4"Union	Pigtail, CGA540
Air	GM2-TL-AIR	3000 (207)	50~65 (3.4~4.5)	3500 (100)	Rc 3/4"Union	Pigtail, CGA346
	GM2-TM-AIR	3000 (207)	100~125 (6.9~8.6)	4200 (120)	Rc 3/4"Union	Pigtail, CGA346
	GM2-TH-AIR	3000 (207)	155~185 (10.7~12.8)	6000 (170)	Rc 3/4"Union	Pigtail, CGA346
Nitrous Oxide	GM2-TL-N2O	3000 (207)	50~65 (3.4~4.5)	1060 (30)	Rc 3/4"Union	Pigtail, CGA326
	GM2-TM-N2O	3000 (207)	100~125 (6.9~8.6)	1060 (30)	Rc 3/4"Union	Pigtail, CGA326
	GM2-TH-N2O	3000 (207)	155~185 (10.7~12.8)	1060 (30)	Rc 3/4"Union	Pigtail, CGA326
Carbon Dioxide	GM2-TL-CO2	2175 (150)	50~65 (3.4~4.5)	1060 (30)	Rc 3/4"Union	Pigtail, CGA320
	GM2-TM-CO2	2175 (150)	100~125 (6.9~8.6)	1060 (30)	Rc 3/4"Union	Pigtail, CGA320
	GM2-TH-CO2	2175 (150)	155~185 (10.7~12.8)	1060 (30)	Rc 3/4"Union	Pigtail, CGA320
Argon, Helium, Nitrogen	GM2-TL-IN	3000 (207)	50~65 (3.4~4.5)	3500 (100)	Rc 3/4"Union	Pigtail, CGA580
	GM2-TM-IN	3000 (207)	100~125 (6.9~8.6)	4200 (120)	Rc 3/4"Union	Pigtail, CGA580
	GM2-TH-IN	3000 (207)	155~185 (10.7~12.8)	6000 (170)	Rc 3/4"Union	Pigtail, CGA580

GM2-T SERIES

Solutions for Life

Dome-bias Fully-Automatic Touch Screen Manifold Systems

Installation Dimensions

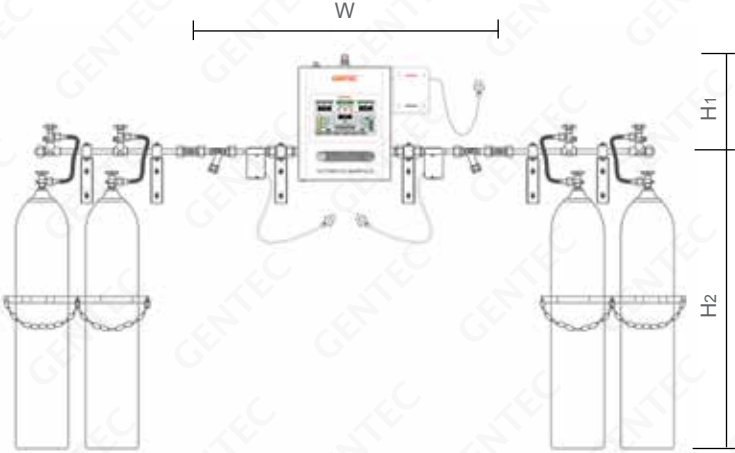

Gas Service	W in.(mm)	H1 in.(mm)	H2 in.(mm)
Oxygen, Air, Nitrous Oxide, Argon, Nitrogen, Helium	44.1 (1120)	15.8 (400)	55.1 (1400)
Carbon Dioxide	56.3 (1430)	15.8 (400)	55.1 (1400)

Manifold System Layouts

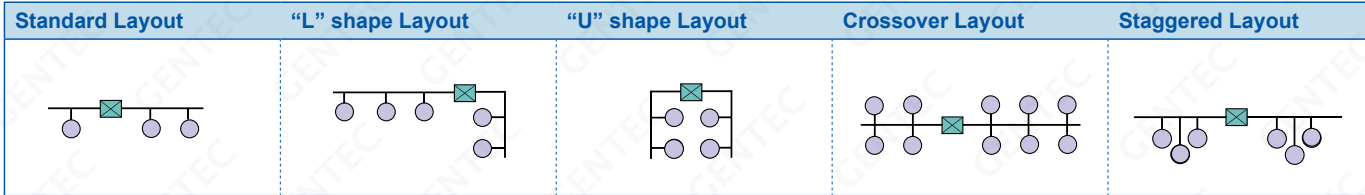

Ordering Information

GM2-T	L	- O2	- U	- (5L x 5R	- S	2)
Series	Delivery Pressure	Gas Service	Standard Code	Number of Cylinders (left-hand / right-hand)	Manifold System Layout	Cylinder Valve Spacing
GM2-T	USA (ISO) L: 55 psi (5 bar) M: 100 psi (8 bar) H: 185 psi (10 bar)	O2: Oxygen AIR: Air N2O: Nitrous Oxide CO2: Carbon Dioxide IN: Ar, He, N ₂	U: USA Standard E: ISO Standard	1L x 2R: One cylinder on the left, Two cylinders on the Right 5L x 5R: Five cylinders on the left, Five cylinders on the Right ...	S: Standard layout L: "L" Shape layout U: "U" shape layout D: Crossover layout X: Staggered layout	1: 5" (127 mm) 2: 10" (254 mm) 3: 13" (330 mm) 4: 18" (457 mm)
				Note: Direction of piping (Right or Left) is indicated by facing the manifold.		

Example: **GM2-TL-O2-U-(5Lx5R-S2)** indicates a 5*5 oxygen cylinder fully-automatic touch screen manifold system.

Distance between two cylinders is 10" on standard horizontal layout. NFPA99 color code (USA)

GM2-TL-O2-U-(0x0) indicates an oxygen changeover system with filters and master shutoff valves. NFPA99 color code (USA)

GM2-TL-O2-U indicates an oxygen changeover system only. NFPA99 color code (USA)

GM3-A SERIES

Dome-bias Fully-Automatic Analog Hybrid Manifold Systems

Solutions for Life

GM3-A Series dome-bias fully-automatic analog hybrid manifold systems is designed to provide an uninterrupted gas supply without any manual adjustments. This system uses liquid cryogenic tank as primary gas source and automatically switches over to the cylinder bank when the tank is below the lower limit. Even in case of a power failure, the system continues to supply gas without interruption. The system is designed to meet the latest edition of NFPA 99 and EN ISO 7396-1 standards.



Features

Automatic Changeover Cabinet

- Fully enclosed, tamper-resistant metal cabinet
- Light indicators provide system status
- Dual-stage regulator, stable output pressure and flow
- Systems for fuel gas come with an anti-explosive device
- External filter facilitates replacement of filtration elements

Pipeline

- Silver brazing on piping joints for maximum leak prevention
- System is designed to accommodate future expansion needs
- System is mounted with gas filters
- Pressure switch port available
- Headers have been tested to withstand high cylinder pressure
- Wall or floor mount available

Standard Construction

- 59" (1500mm) stainless steel braided pigtails for primary gas supply and 36" (914mm) stainless steel braided pigtails for auxiliary air supply
- Rigid copper pigtails are standard when gas service is oxygen
- Carbon dioxide manifold systems are provided with H900G electric gas heater

Specifications

Gas Service	Series	Max. Inlet Pressure psi (bar)		Delivery Pressure psi (bar)	Max. Delivery Flow SCFH (m³/h)	Outlet Connection	Pigtail Specifications	
		Primary	Secondary				Primary	Secondary
Oxygen	GM3-AL-O2	435 (30)	3000 (207)	50~65 (3.4~4.5)	1060~3500 (30~100)	Rc 3/4"Union	Rc 3/4"Union	Pigtail, CGA540
	GM3-AM-O2	435 (30)	3000 (207)	100~125 (6.9~8.6)	1060~4200 (30~120)	Rc 3/4"Union	Rc 3/4"Union	Pigtail, CGA540
	GM3-AH-O2	435 (30)	3000 (207)	155~185 (10.7~12.8)	1060~6000 (30~170)	Rc 3/4"Union	Rc 3/4"Union	Pigtail, CGA540
Air	GM3-AL-AIR	435 (30)	3000 (207)	50~65 (3.4~4.5)	1060~3500 (30~100)	Rc 3/4"Union	Rc 3/4"Union	Pigtail, CGA346
	GM3-AM-AIR	435 (30)	3000 (207)	100~125 (6.9~8.6)	1060~4200 (30~120)	Rc 3/4"Union	Rc 3/4"Union	Pigtail, CGA346
	GM3-AH-AIR	435 (30)	3000 (207)	155~185 (10.7~12.8)	1060~6000 (30~170)	Rc 3/4"Union	Rc 3/4"Union	Pigtail, CGA346
Carbon Dioxide	GM3-AL-CO2	435 (30)	3000 (207)	50~65 (3.4~4.5)	1060~1750 (30~50)	Rc 3/4"Union	Rc 3/4"Union	Pigtail, CGA320
	GM3-AM-CO2	435 (30)	3000 (207)	100~125 (6.9~8.6)	1060~1750 (30~50)	Rc 3/4"Union	Rc 3/4"Union	Pigtail, CGA320
Argon, Nitrogen	GM3-AL-IN	435 (30)	3000 (207)	50~65 (3.4~4.5)	1060~3500 (30~100)	Rc 3/4"Union	Rc 3/4"Union	Pigtail, CGA580
	GM3-AM-IN	435 (30)	3000 (207)	100~125 (6.9~8.6)	1060~4200 (30~120)	Rc 3/4"Union	Rc 3/4"Union	Pigtail, CGA580
	GM3-AH-IN	435 (30)	3000 (207)	155~185 (10.7~12.8)	1060~6000 (30~170)	Rc 3/4"Union	Rc 3/4"Union	Pigtail, CGA580

Installation Dimensions

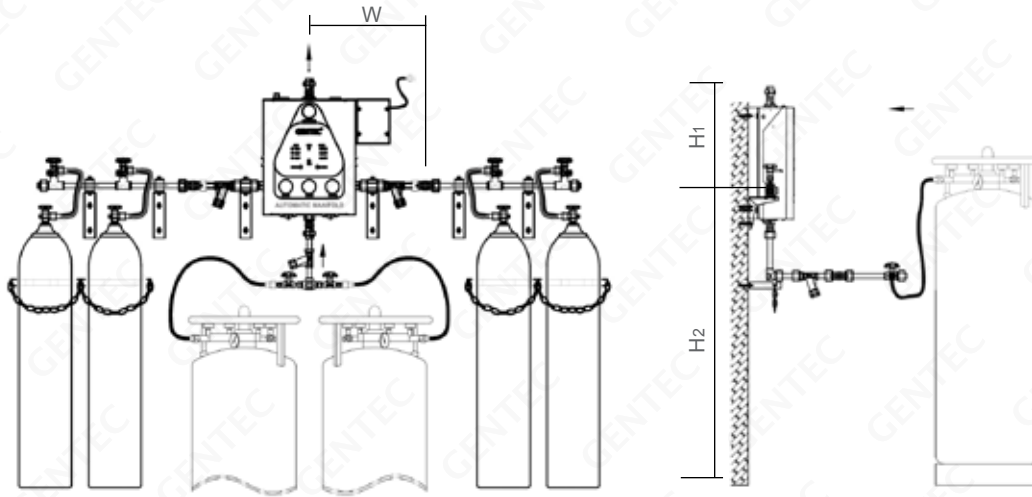

Gas Service	W in.(mm)	H1 in.(mm)	H2 in.(mm)
Oxygen, Air, Argon, Nitrogen	44.1 (1120)	15.8 (400)	55.1 (1400)
Carbon Dioxide	56.3 (1430)	15.8 (400)	55.1 (1400)

Manifold System Layouts

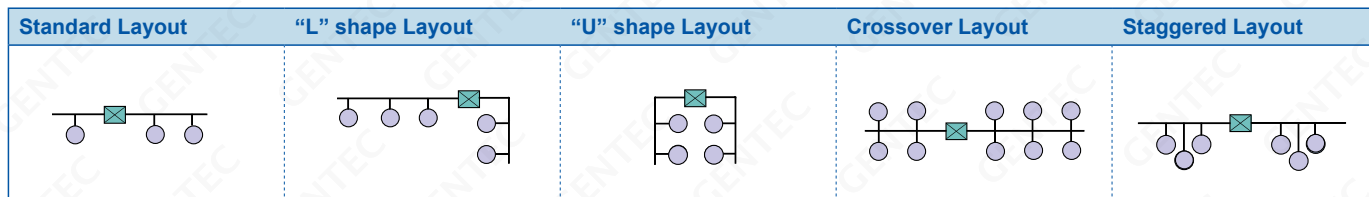

Ordering Information

GM3-A	L	- O2	- U	- (5L x 5R	- S	2)
Series	Delivery Pressure	Gas Service	Standard Code	Number of Cylinders (left-hand / right-hand)	Manifold System Layout	Cylinder Valve Spacing
GM3-A	USA (ISO) L: 55 psi (5 bar) M: 100 psi (8 bar) H: 185 psi (10 bar)	O2: Oxygen AIR: Air CO2: Carbon Dioxide IN: Ar, N ₂	U: USA Standard E: ISO Standard	1L x 2R: One cylinder on the left, Two cylinders on the Right 5L x 5R: Five cylinders on the left, Five cylinders on the Right ...	S: Standard layout L: "L" Shape layout U: "U" shape layout D: Crossover layout X: Staggered layout	1: 5" (127 mm) 2: 10" (254 mm) 3: 13" (330 mm) 4: 18" (457 mm)
<p>Note: Direction of piping (Right or Left) is indicated by facing the manifold.</p>						

Example: **GM3-AL-O2-U-(5Lx5R-S2)** indicates a 5*5 oxygen cylinder fully-automatic analog hybrid manifold system.

Distance between two cylinders is 10" on standard horizontal layout. NFPA99 color code (USA)

GM3-AL-O2-U-(0x0) indicates an oxygen changeover system with filters and master shutoff valves. NFPA99 color code (USA)

GM3-AL-O2-U indicates an oxygen changeover system only. NFPA99 color code (USA)

GM3-T SERIES

Dome-bias Fully-Automatic Touch Screen Hybrid Manifold Systems

Solutions for Life

GM3-T series dome-bias fully-automatic touch screen hybrid manifold systems is designed to provide an uninterrupted gas supply without any manual adjustments. This system uses liquid cryogenic tank as primary gas source and automatically switches over to the cylinder bank when the tank is below the lower limit. Even in case of a power failure, the system continues to supply gas without interruption. The system is designed to meet the latest edition of NFPA 99 and EN ISO 7396-1 standards.



Features

Automatic Changeover Cabinet

- Fully enclosed, dust-proof metal cabinet
- 10" Touch Screen Display with Password protected interface
- Dual-stage regulator, stable output pressure and flow
- With safety device to prevent the system pressure from being too high
- Full networking capabilities including Modbus RTU/TCP, UDP protocols, Auto generated alarm table and trend log

Header

- Silver brazing on piping joints for maximum leak prevention
- System is designed to accommodate future expansion needs
- System is mounted with gas filters
- Pressure switch port available
- Headers have been tested to withstand high cylinder pressure
- Cleaned for Oxygen use according to CGA 4.1 and ISO 15001
- Comply with NFPA 99, HTM 02-01 and ISO 7396
- Wall or floor mount available

Standard Construction

- 59" (1500mm) stainless steel braided pigtails for primary gas supply and 36" (914mm) stainless steel braided pigtails for auxiliary air supply
- Rigid copper pigtails are standard when gas service is oxygen
- Carbon dioxide manifold systems are provided with H900G electric gas heater

Specifications

Gas Service	Series	Max. Inlet Pressure psi (bar)		Delivery Pressure psi (bar)	Max. Delivery Flow SCFH (m ³ /h)	Outlet Connection	Pigtail Specifications	
		Primary	Secondary				Primary	Secondary
Oxygen	GM3-TL-O2	435 (30)	3000 (207)	50~65 (3.4~4.5)	1060~3500 (30~100)	Rc 3/4"Union	Rc 3/4"Union	Pigtail, CGA540
	GM3-TM-O2	435 (30)	3000 (207)	100~125 (6.9~8.6)	1060~4200 (30~120)	Rc 3/4"Union	Rc 3/4"Union	Pigtail, CGA540
	GM3-TH-O2	435 (30)	3000 (207)	155~185 (10.7~12.8)	1060~6000 (30~170)	Rc 3/4"Union	Rc 3/4"Union	Pigtail, CGA540
Air	GM3-TL-AIR	435 (30)	3000 (207)	50~65 (3.4~4.5)	1060~3500 (30~100)	Rc 3/4"Union	Rc 3/4"Union	Pigtail, CGA346
	GM3-TM-AIR	435 (30)	3000 (207)	100~125 (6.9~8.6)	1060~4200 (30~120)	Rc 3/4"Union	Rc 3/4"Union	Pigtail, CGA346
	GM3-TH-AIR	435 (30)	3000 (207)	155~185 (10.7~12.8)	1060~6000 (30~170)	Rc 3/4"Union	Rc 3/4"Union	Pigtail, CGA346
Carbon Dioxide	GM3-TL-CO2	435 (30)	3000 (207)	50~65 (3.4~4.5)	1060~1750 (30~50)	Rc 3/4"Union	Rc 3/4"Union	Pigtail, CGA320
	GM3-TM-CO2	435 (30)	3000 (207)	100~125 (6.9~8.6)	1060~1750 (30~50)	Rc 3/4"Union	Rc 3/4"Union	Pigtail, CGA320
Argon, Nitrogen	GM3-TL-IN	435 (30)	3000 (207)	50~65 (3.4~4.5)	1060~3500 (30~100)	Rc 3/4"Union	Rc 3/4"Union	Pigtail, CGA580
	GM3-TM-IN	435 (30)	3000 (207)	100~125 (6.9~8.6)	1060~4200 (30~120)	Rc 3/4"Union	Rc 3/4"Union	Pigtail, CGA580
	GM3-TH-IN	435 (30)	3000 (207)	155~185 (10.7~12.8)	1060~6000 (30~170)	Rc 3/4"Union	Rc 3/4"Union	Pigtail, CGA580

GM3-T SERIES

Solutions for Life

Dome-bias Fully-Automatic Touch Screen Hybrid Manifold Systems

Installation Dimensions

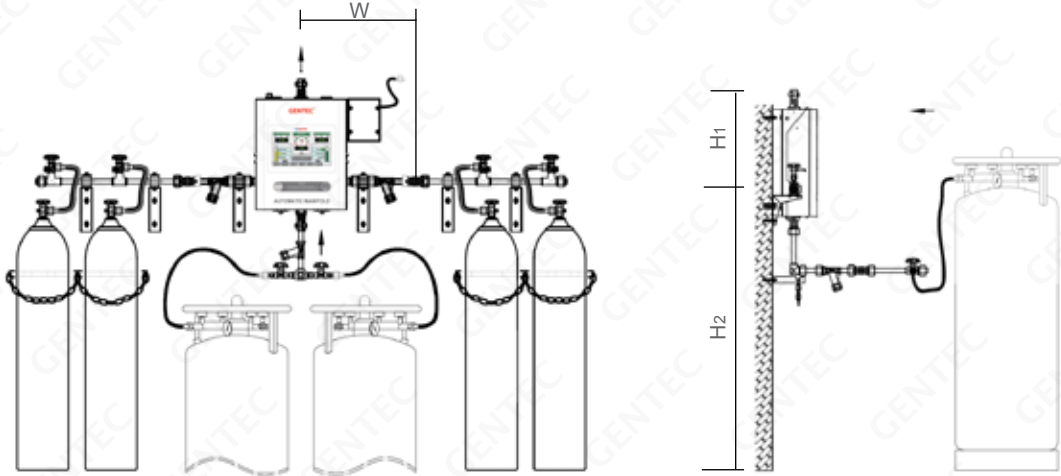

Gas Service	W in.(mm)	H1 in.(mm)	H2 in.(mm)
Oxygen, Air, Argon, Nitrogen	44.1 (1120)	15.8 (400)	55.1 (1400)
Carbon Dioxide	56.3 (1430)	15.8 (400)	55.1 (1400)

Manifold System Layouts

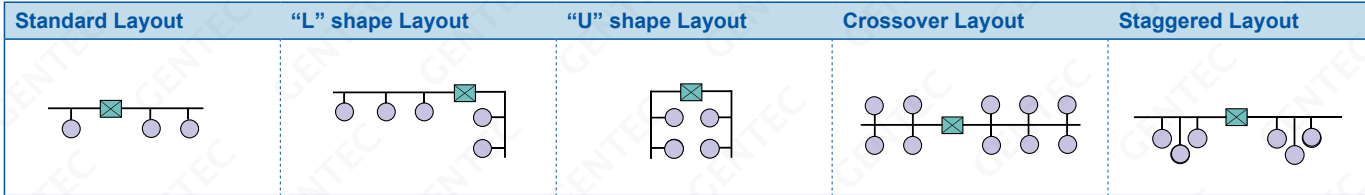

Ordering Information

GM3-T	L	- O2	- U	- (5L x 5R	- S	2)
Series	Delivery Pressure	Gas Service	Standard Code	Number of Cylinders (left-hand / right-hand)	Manifold System Layout	Cylinder Valve Spacing
GM3-T	USA (ISO) L: 55 psi (5 bar) M: 100 psi (8 bar) H: 185 psi (10 bar)	O2: Oxygen AIR: Air CO2: Carbon Dioxide IN: Ar, N ₂	U: USA Standard E: ISO Standard	1L x 2R: One cylinder on the left, Two cylinders on the Right 5L x 5R: Five cylinders on the left, Five cylinders on the Right ...	S: Standard layout L: "L" Shape layout U: "U" shape layout D: Crossover layout X: Staggered layout	1: 5" (127 mm) 2: 10" (254 mm) 3: 13" (330 mm) 4: 18" (457 mm)
<p>Note: Direction of piping (Right or Left) is indicated by facing the manifold.</p>						

Example: **GM3-TL-O2-U-(5Lx5R-S2)** indicates a 5*5 oxygen cylinder fully-automatic touch screen hybrid manifold system.

Distance between two cylinders is 10" on standard horizontal layout. NFPA99 color code (USA)

GM3-TL-O2-U-(0x0) indicates an oxygen changeover system with filters and master shutoff valves. NFPA99 color code (USA)

GM3-TL-O2-U indicates an oxygen changeover system only. NFPA99 color code (USA)

5500E SERIES

Explosion-proof Fully-Automatic Manifold Systems

Solutions for Life

5500E series explosion-proof fully-automatic manifold systems are suitable for flammable gases and are specially designed to provide an uninterrupted gas supply without any manual adjustments. This system automatically changes over when the primary cylinder bank is depleted. Even in case of power failure, the system continues to supply gas without interruption.



Features

Automatic Changeover Cabinet

- Fully enclosed, tamper-resistant metal cabinet
- Light indicators provide system status
- Systems for fuel gas come with an anti-explosive device
- External filter facilitates replacement of filtration elements

Pipeline

- Silver brazing on piping joints for maximum leak prevention
- System is designed to accommodate future expansion needs
- System is mounted with gas filters
- Pressure switch port available
- Headers have been tested to withstand high cylinder pressure
- Wall or floor mount available

Standard Construction

- 36" (914mm) flexible high pressure stainless steel braided pigtailed with check valve
- For Acetylene or Fuel gas model, regulator outlet is equipped with a dry flashback arrestor (FA30PF) for additional safety.
- Siphon-type cylinder should not be used in the manifold system

Specifications

Gas Service	Series	Max. Inlet Pressure psi (bar)	Delivery Pressure psi (bar)	Max. Delivery Flow SCFH (m ³ /h)	Outlet Connection	Pigtail Specifications
Acetylene	5500EY	435 (30)	1.5~14.5 (0.1~1)	700 (20)	3/4" NPT (M)	Pigtail, CGA510
Propane	5500EF	435 (30)	4.4~125 (0.3~8.5)	1050 (30)	3/4" NPT (M)	Pigtail, CGA510
Hydrogen	5500EH	3000 (207)	10~200 (0.7~14)	10500 (300)	3/4" NPT (M)	Pigtail, CGA350

Installation Dimensions

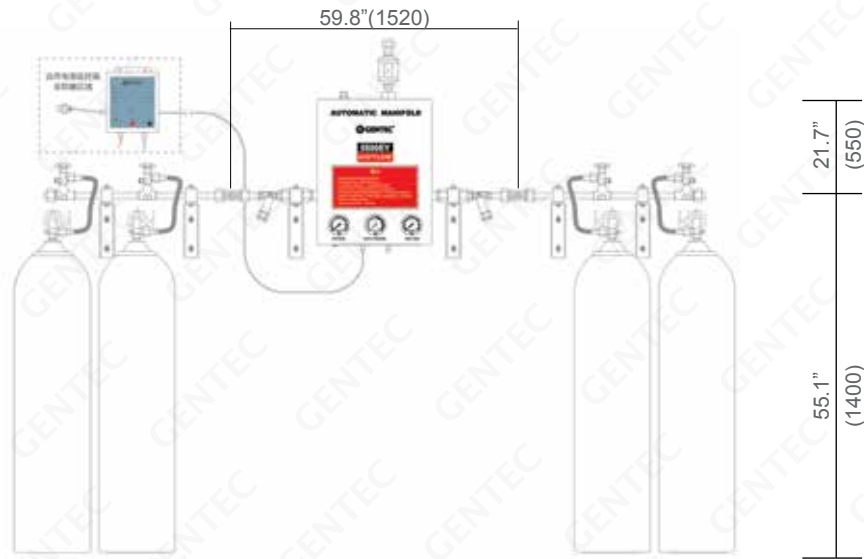

Manifold System Layouts

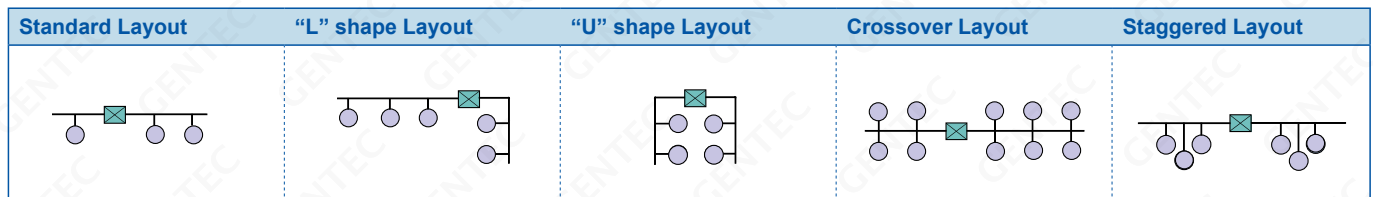

Ordering Information

55	1	2	E	Y	- 5 x 5	- 1
Series	Manifold System Layout	Cylinder Valve Spacing	Explosion-proof Type	Gas Service	Number of Cylinders (left-hand / right-hand)	Type of Mounting
55	1: Standard layout 2: "L" Shape layout 3: "U" shape layout 4: Crossover layout 5: Staggered layout	1: 5" (127 mm) 2: 10" (254 mm) 3: 13" (330 mm) 4: 18" (457 mm)	E: Explosion-proof type	Y: Acetylene F: Propane H: Hydrogen	1 x 2: One cylinder on the left, Two cylinders on the Right 5 x 5: Five cylinders on the left, Five cylinders on the Right ...	1: Wall mount 2: Floor mount
<p>Note: Direction of piping (Right or Left) is indicated by facing the manifold.</p>						

Example: 5512EY-5x5-1 indicates a 5 x 5 cylinder acetylene fully-automatic manifold system.
Distance between two cylinders is 10" on standard horizontal layout.

5600 SERIES

Semi-Automatic Manifold Systems for Liquid Vessel

Solutions for Life

5600 series semi-automatic manifold systems is designed specifically for liquid vessels to provide an uninterrupted gas supply. When the primary liquid vessel is depleted, the changeover takes place automatically to provide continuous supply of gas from the reserve liquid vessel. Upon changing the vessel, the regulators on both banks need to be re-adjusted in order for the changover to occur automatically next time.



Features

- Semi-automatic changeover control
- Unique changeover valve provides uninterrupted supply of gas from primary and reserve vessels
- The whole system is pressure resistance tested
- Wall mount available

Ordering Information

Gas Service	Series	Max. Inlet Pressure psi (bar)	Delivery Pressure psi (bar)	Max. Delivery Flow SCFH (m ³ /h)	Outlet Connection	Pigtail Specifications
Carbon Dioxide	5600C	435 (30)	5~125 (0.35~8.6)	1050 (30)	3/4" NPT (M)	Pigtail, CGA320
Argon		435 (30)	5~125 (0.35~8.6)	1750 (50)	3/4" NPT (M)	Pigtail, CGA580
Helium	5600IN	435 (30)	5~125 (0.35~8.6)	5250 (150)	3/4" NPT (M)	Pigtail, CGA580
Nitrogen		435 (30)	5~125 (0.35~8.6)	3150 (90)	3/4" NPT (M)	Pigtail, CGA580

Note: The flow rate depends on the vaporization rate of gas supplied.

- Please specify the "model number" when ordering.
Example: "5600C" indicates semi-automatic manifold system for liquid vessels.

5700A SERIES

Solutions for Life

Fully-Automatic Analog Manifold Systems for Liquid Vessel

5700A series fully-automatic analog manifold systems is designed specifically for liquid vessels to provide an uninterrupted gas supply without any manual operation. This system automatically changes over when the primary bank is depleted. Even in case of power failure, the system continues to operate without interruption.



Features

Automatic Changeover Cabinet

- Fully enclosed, tamper-resistant metal cabinet
- Light indicators provide system status, with changeover alarm function
- Gas saving structure reduces gas consumption in the reserve cylinder, safe and economical
- Pressure switch valve control
- External filter provides easy replacement of filtration element

Header

- Silver brazing on piping joints for maximum leak prevention
- System is designed to accommodate future expansion needs
- System is mounted with gas filters
- Pressure switch port available
- Headers have been tested to withstand high cylinder pressure
- Wall or floor mount available

Ordering Information

Gas Service	Series	Max. Inlet Pressure psi (bar)	Delivery Pressure psi (bar)	Max. Delivery Flow SCFH (m ³ /h)	Outlet Connection	Pigtail Specifications
Oxygen	5700AX	435 (30)	4.4~87 (0.3~6.0)	2450 (70)	3/4" NPT (M)	Pigtail, CGA540
Carbon Dioxide	5700AC	435 (30)	4.4~87 (0.3~6.0)	1050 (30)	3/4" NPT (M)	Pigtail, CGA320
Argon	5700AIN	435 (30)	4.4~87 (0.3~6.0)	1750 (50)	3/4" NPT (M)	Pigtail, CGA580
Helium		435 (30)	4.4~87 (0.3~6.0)	6300 (180)	3/4" NPT (M)	Pigtail, CGA580
Nitrogen		435 (30)	4.4~87 (0.3~6.0)	2800 (80)	3/4" NPT (M)	Pigtail, CGA580

Note: The flow rate depends on the vaporization rate of gas supplied.

- Please specify the "model number" when ordering.

Example: "5700AC" indicates fully-automatic analog manifold system for liquid vessels.

Please provide gas phase delivery pressure of Dewar Vessel and operating pressure of the equipment to help us set the system parameters.

5700AD SERIES

Fully-Automatic Digital Manifold Systems for Liquid Vessel

Solutions for Life

5700AD series fully-automatic digital manifold systems is designed specifically for liquid vessels to provide an uninterrupted gas supply without any manual operation. This system automatically changes over when the primary bank is depleted. Even in case of power failure, the system continues to operate without interruption.



Features

Automatic Changeover Cabinet

- Fully enclosed, tamper-resistant metal cabinet
- On-site Display: Indicator lights of system status, Gauge Pressures, visual Remote alarm box provide system status; Digital display of pressure; with changeover alarm function
- Pressure switch control
- External filter provides easy replacement of filtration element
- Patent pending changeover technology

Header

- Silver brazing on piping joints for maximum leak prevention
- System is designed to accommodate future expansion needs
- System is mounted with gas filters
- Pressure switch port available
- Headers have been tested to withstand high cylinder pressure
- Wall or floor mount available

Ordering Information

Gas Service	Series	Max. Inlet Pressure psi (bar)	Delivery Pressure psi (bar)	Max. Delivery Flow SCFH (m ³ /h)	Outlet Connection	Pigtail Specifications
Oxygen	5700ADX	435 (30)	4.4~87 (0.3~6.0)	2450 (70)	3/4" NPT (M)	Pigtail, CGA540
Carbon Dioxide	5700ADC	435 (30)	4.4~87 (0.3~6.0)	1050 (30)	3/4" NPT (M)	Pigtail, CGA320
Argon	5700ADIN	435 (30)	4.4~87 (0.3~6.0)	1750 (50)	3/4" NPT (M)	Pigtail, CGA580
Helium		435 (30)	4.4~87 (0.3~6.0)	6300 (180)	3/4" NPT (M)	Pigtail, CGA580
Nitrogen		435 (30)	4.4~87 (0.3~6.0)	2800 (80)	3/4" NPT (M)	Pigtail, CGA580

Note: The flow rate depends on the vaporization rate of gas supplied.

- Please specify the "model number" when ordering.

Example: "5700ADX" indicates automatic digital manifold system for liquid vessels.

MANIFOLD CHANGEOVER CABINET

Solutions for Life

Manifold Changeover Cabinet

Single-bank Changeover System

Designed for Single-Bank cylinder manifold systems (right or left).

- Inlet connection thread: 1-11 1/2NPS RH(M)
- Outlet connection thread: 3/4" NPT(M)
- Max. Inlet Pressure: 3000 psi for Oxygen, Carbon Dioxide, Argon, Nitrogen, Helium, Air
400 psi for Acetylene, Propane



5200X-00R



5200X-00L

Model Number	Gas Service	Description
5200X-00L	Oxygen	Left Bank
5200X-00R	Oxygen	Right Bank
5200YD-00L	Acetylene	Left Bank With FA (FA30PF)
5200YD-00R	Acetylene	Right Bank With FA (FA30PF)
5200FD-00L	Propane	Left Bank With FA (FA30PF)
5200FD-00R	Propane	Right Bank With FA (FA30PF)
5200FH-00R	Propane	Left Bank With FA (GFA-1000 LPG)
5200C-00L	Carbon Dioxide	Left Bank With Gas Heater
5200C-00R	Carbon Dioxide	Right Bank With Gas Heater
5200IN-00L	Argon, Nitrogen, Helium	Left Bank
5200IN-00R	Argon, Nitrogen, Helium	Right Bank
5200Q-00L	Air	Left Bank
5200Q-00R	Air	Right Bank
5200H-00L	Hydrogen	Left Bank
5200H-00R	Hydrogen	Right Bank

Dual-bank Changeover System

Designed for dual-bank manifold systems

- Inlet connection thread: 1"-11-1/2NPS RH (M)



5300X-00

Model Number	Gas Service	Accessories
5300X-00	Oxygen	
5300YD-00	Acetylene	With FA (FA30PF)
5300FD-00	Acetylene	With FA (FA30PF)
5300C-00	Carbon Dioxide	With Gas Heater
5300IN-00	Argon, Nitrogen, Helium	
5300H-00	Hydrogen	

MANIFOLD CHANGEOVER CABINET

Manifold Changeover Cabinet

Solutions for Life

Semi-automatic Changeover Manifold Systems



5400X-00

Designed for semi-automatic changeover manifold systems.

- Inlet connection thread: 1-11 1/2NPS RH(M)
- Outlet connection thread: 3/4" NPT(M)
- Max. Inlet Pressure: 3000 psi for Oxygen, Carbon Dioxide, Argon, Nitrogen, Helium, Air; 400 psi for Acetylene, Propane

Model Number	Gas Service	Accessories
5400X-00	Oxygen	-
5400YD-00	Acetylene	With FA (FA30PF)
5400FD-00	Propane	With FA (FA30PF)
5400C-00	Carbon Dioxide	With Gas Heater
5400IN-00	Argon, Nitrogen, Helium	-
5400Q-00	Air	-
5400H-00	Hydrogen	-

Automatic Changeover Cabinet



GM2-AL-O2-U-(0X0)

- Suitable for automatic manifold changeover system. Even in case of power failure, the system continues to operate without interruption
- Detachable rollover cabinet cover, easy to maintain and service
- Three-way gas pressure display
- The panel shows the system working status
- Two-stage regulator construction for stable gas delivery
- High accuracy pressure switch control
- Wall mount available
- Inlet connection thread: 1"-11-1/2NPS(M)
- Outlet connection thread: Rc 3/4" Union
- Safety Discharge Port: G 3/4"
- Electrical setting: Operating voltage 220VAC, insulation between strong and weak current
- Dimensions: 20"(W) x 24"(H) x 8"(D) (508 x 610 x 203mm)

Model Number	Gas Service	Max. Inlet Pressure psi (bar)	Delivery Pressure psi (bar)	Max. Delivery Flow SCFH (m ³ /h)	Accessories
GM2-A-O2-U-(0X0)	Oxygen	3000 (207)	55, 100, 185 (5, 8, 10)	6000 (170)	-
	Argon	3000 (207)	55, 100, 185 (5, 8, 10)	6000 (170)	-
GM2-A-IN-U-(0X0)	Helium	3000 (207)	55, 100, 185 (5, 8, 10)	6000 (170)	-
	Nitrogen	3000 (207)	55, 100, 185 (5, 8, 10)	6000 (170)	-
GM2-A-N2O-U-(0X0)	Nitrous Oxide	2175 (150)	55, 100, 185 (5, 8, 10)	1750 (50)	-
GM2-A-CO2-U-(0X0)	Carbon Dioxide	2175 (150)	55, 100, 185 (5, 8, 10)	1750 (50)	With Gas Heater

MANIFOLD COMPONENTS

Manifold Pipings & Header Extensions

Solutions for Life

Manifold Pipings

Header extension consists of a gas delivery pipe and header valves. It is expandable for different application requirements.

GHER-310X (right-hand manifold pipings)



GHEL-310X (Left-hand manifold pipings)



GHEC-310X (Dual manifold pipings)



GHNS-310X

(Single valve per header block for straight configuration)



GHND-310X

(Dual Valves per header block for staggered configuration)



GHNQ-102X

(Quad Valves per header block for space saving)



- Machined with class "A" brass stock
- Silver brazing on piping joints for maximum leak prevention
- Maximum working pressure: 3000 psi
- Inlet (Header valve): Fuel Gas-CGA 510
Other gases-CGA540
- Outlet: 1"-11-1/2NPS

Ordering Information

- Please follow the instructions below to select the correct model number.

GH	E	R	- 3	10	X
Series	Valve Type	Piping Shape & Layout joints	No. of Joints	Joints Spacing	Gas Service
GH	E: Globe Valve	R: Right-hand manifold pipings L: Right-hand manifold pipings C: Dual manifold pipings	2: Two Joints 3: Three Joints 4: Four Joints	02: 1.5" (40 mm) 05: 5" (127 mm) 10: 10" (254 mm)	X: Oxygen Y: Acetylene F: Propane
	N: Check valve	S: Single joint manifold pipings D: Dual joints manifold pipings Q: Quad joints manifold pipings	5: Five Joints ...	13: 13" (330 mm) 18: 18" (457 mm) (Does not apply to "C" Piping Shape.)	C: Carbon Dioxide IN: Argon, Nitrogen, Helium Q: Air

Example: GHER-210X indicates a right-hand oxygen manifold piping system with 2 joints, and 10" joint distance.

Header Extensions



GET-9X

GCC-4



GEE-11

Model Number	Length	Inlet Connection	Outlet Connection	Description
GEE-4	4-1/2"	1"-11-1/2NPS-RH (M)	1"-11-1/2NPS-RH (F)	Elbow
GEE-8	8-1/3"	1"-11-1/2NPS-RH (M)	1"-11-1/2NPS-RH (F)	
GEE-11	11-1/3"	1"-11-1/2NPS-RH (M)	1"-11-1/2NPS-RH (F)	
GET-9X	8-2/3"	1"-11-1/2NPS-RH (F)	1"-11-1/2NPS-RH (F)	"T" shape
GCC-4	4"	1"-11-1/2NPS-RH (F)	1"-11-1/2NPS-RH (F)	Extension
GCC-4L	4"	1"-11-1/2NPS-RH (F)	1"-11-1/2NPS-LH (F)	

MANIFOLD COMPONENTS

Valves & Accessories, Manifold Components

Solutions for Life

Valves & Accessories



GMV-81



H900G



GMV-180



B-RV95-T350-NT4



GMV-90X



B-BV312-NT8

Model Number	Inlet / Outlet Connection	Gas Service	Description
GMV-81	1"-11-1/2NPS	*All Gas	Master Valve, Work Pressure: 4500 psi
GMV-180	1"-11-1/2NPS	*All Gas	Master Valve, Work Pressure: 2800 psi
GMV-90X	CGA540 / 1/2" NPT	O ₂ , CO ₂ , Air, Ar, He, N ₂	Header Valve
GMV-90F	CGA510 / 1/2" NPT	C ₂ H ₂ , C ₃ H ₈ , H ₂	
GMV-91X	1/2" NPT / G5/8-RH	O ₂ , CO ₂ , Air, Ar, He, N ₂	In-line Check Valve
GMV-91F	1/2" NPT / G5/8-LH	C ₂ H ₂ , C ₃ H ₈ , H ₂	
B-RV95-T350-NT4	1/4"NPT	*All Gas	Relief Valve, Set Pressure: 350 psi
B-RV95-T280-NT4	1/4"NPT	*All Gas	Relief Valve, Set Pressure: 280 psi
B-RV95-T150-NT4	1/4"NPT	*All Gas	Relief Valve, Set Pressure: 150 psi
B-RV95-F80-NT4	1/4"NPT	*All Gas	Relief Valve, Set Pressure: 80 psi
B-BV312-NT8	1/4"NPT	*All Gas	3-Way Ball Valve, Work Pressure: 450 psi
H900G	1" -11-1/2 NPS RH	CO ₂	Heater, 110V or 220V Work Pressure: 2200 psi

*All gases = non-corrosive gases



R155-103A



R155-103



GHER-210-02



GCC-A



EN-100A



GHFN-X



GHFA-J1

Model Number	Description
R155-103	1/2"NPT
R155-103A	1/4"NPT
R155-103B	3/4"NPT
R155-111	Adaptor, 1/4"NPT(M) / 1"-11-1/2NPS-RH(M)
R155-111A	Adaptor, 1/4"NPT(M) / 1"-11-1/2NPS-LH(M)
R155-110	Adaptor, 1/2"NPT(M) / 1"-11-1/2NPS-RH(M)
GHER-210-02	Retaining Nut, 27/32"-20UNS(F)
GCC-A	Adaptor, 3/4"NPT(M) / 1"-11-1/2NPS-RH(M)
GCC-C	Adaptor, 3/4"NPT(M) / 1"-11-1/2NPS-LH(M)
GCC-B	Adaptor, 3/4"NPT(M) / 3/4"NPT(M)
GCC-D	Adaptor, 3/4"NPT(M) / 1/2"NPT(M)
EN-100A	Plug
GHFN-X	Nut, 1"-11-1/2NPS-RH(F)

Manifold Components

- Machined with class "A" brass stock
Maximum working pressure: 3000 psi
- D: 22.5mm, ID: 11.5mm



Length	1/2" NPT	1/2"
1-1/2" (38mm)	GHBP-1A	-
2" (51mm)	GHBP-2A	GHBP-2C
4" (102mm)	GHBP-4A	GHBP-4C
6" (152mm)	GHBP-6A	GHBP-6C
8-1/2" (216mm)	GHBP-8A	GHBP-8C
11-1/2" (292mm)	GHBP-11A	GHBP-11C
6' (1829mm)	-	GHBP-180C
12' (3658mm)	-	GHBP-360C

MANIFOLD COMPONENTS

Solutions for Life

Manifold Fittings

- Machined with class "A" brass stock
- Maximum working pressure: 3000 psi

Three-way Connector

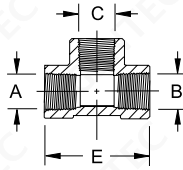

Figure 1

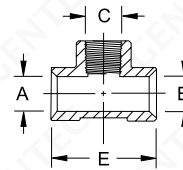

Figure 2

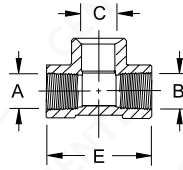

Figure 3

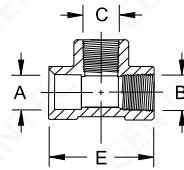

Figure 4

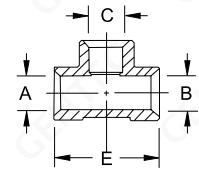

Figure 5

Model Number	A	B	C	E	Figure
GHFT-1A	1/2" NPT	1/2" NPT	1/2" NPT	2-1/2"	1
GHFT-1B	0.873-0.886	0.873-0.886	1/2" NPT	2-1/2"	2
GHFT-1C	1/2" NPT	1/2" NPT	0.873-0.886	2-1/2"	3
GHFT-1D	0.873-0.886	1/2" NPT	1/2" NPT	2-1/2"	4
GHFT-1E	0.873-0.886	0.873-0.886	0.873-0.886	2-1/2"	5

Four-way Connector

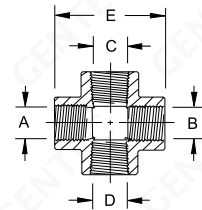

Figure 1

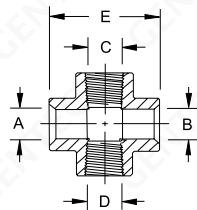

Figure 2

Model Number	A	B	C	D	E	Figure
GHFC-1A	1/2" NPT	1/2" NPT	1/2" NPT	1/2" NPT	2-3/4"	1
GHFC-1B	0.873-0.886	0.873-0.886	1/2" NPT	1/2" NPT	2-3/4"	2

Elbow Connector

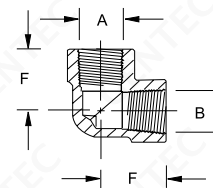

Figure 1

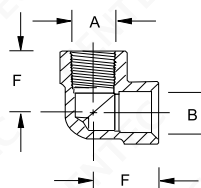

Figure 2

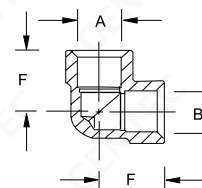

Figure 3

Model Number	A	B	E	Figure
GHFE-1A	1/2" NPT	1/2" NPT	1-1/4"	1
GHFE-1B	1/2" NPT	0.873-0.886	1-1/4"	2
GHFE-1C	0.873-0.886	0.873-0.886	1-1/4"	3

MANIFOLD COMPONENTS

Pigtails, Wall Mounts, Pipe Holders and Pipe Supports

Solutions for Life

High Pressure Pigtails

For use with GENTEC manifold systems only.



Copper Pigtail



Stainless Steel Flexible Pigtail

GPF - 24	CVO -	C540 -	510			
Model Number	Length	CV / FA	Connection (Cylinder)	Connection (Manifold)	Gas Service	Gas Not Recommended
GPF: Flexible pigtail (Teflon-lined)	24:24" (610 mm)	Blank: Without	C320: CGA320 (CO2)	510: CGA 510	Strong oxidizing Strong corrosive gas	High Pressure Medical Oxygen*
	36:36" (914 mm)	check valve	C326: CGA 326 (N2O)	(Fuel Gas)		
	59:59" (1500 mm)		C346: CGA 346 (Air)	540: CGA 540		
GPS: Stainless steel flexible pigtail (316SST) pigtail(316SST) pigtail(316SST)	79:79" (2000 mm)	CVO: Check valve at manifold header side	C350: CGA 350 (C2H2)	(Inert Gas)	Fuel gas Non fuel gas	High Pressure Oxygen**
		CVI: Check valve at cylinder valve side	C510: CGA 510 (C2H2, Low Pressure)			
		FA: With flashback arrestor	C540: CGA 540 (O2)			
GPR: Copper rigid pigtail			C580: CGA 580 (Inert Gas)		Oxygen	Acetylene
			BS02: BS341 No 2 (C2H2)			
			BS03: BS341 No 3 (Air, O2, N2, Inert Gas)			
			BS04: BS341 No 4 (H2,CH4)			
			BS08: BS341 No 8 (CO2)			
			BS13: BS341 No 13 (N2O)			
		DN1: DIN 477 No 1 (H2, C2H6, C2H4, Fuel Gas)				
		DN3: DIN 477 No 3 (C2H2)				
		DN6 : DIN 477 No 6 (Ar, CO2, Inert Gas)				
		DN8: DIN 477 No 8 (N2O)				
		DN10: DIN 477 No 10 (N2)				

* According to HTM, high pressure medical oxygen is not compatible with Teflon lining pigtail.

** High pressure oxygen should not be used with stainless steel pigtail according to relevant standards.

Cylinder Wall Mounts, Pipe Holders and Pipe Supports



GMB-1



GMB-3



CB-2



GMB-7



GMB-9B

Model Number	Description
GMB-1	Single Cylinder Wall Mount, OD. 9" (229 mm)
GMB-2	Single Cylinder Wall Mount, OD. 14" (356 mm)
GMB-3	Dual Cylinder Wall Mount, OD. 9" (229 mm)
GMB-4	Dual Cylinder Wall Mount, OD. 14" (356 mm)
GMB-7	Mounting Bracket
GMB-9B	Header Support
CB-2	Single Cylinder Wall Bracket with strap

MANIFOLD COMPONENTS

Solutions for Life

Flashback Arrestors & Pressure Switches & Pressure Transmitter

In-line Low Pressure Flashback Arrestors

Designed for use on Acetylene or Fuel Gas Manifold Systems with low pressure piping system to protect the main gas supply from the dangers of reverse flow and flashbacks by stainless steel sintered elements and check valves.

Model Number	Gas Service	Working Pressure psi (bar)	Delivery Flow (SCFH)	Inlet / Outlet Connection
FA30PF	Acetylene, Propane, LPG	22 (1.5)	2450	3/4" NPT(F) / 3/4" NPT(F)
FA30PO	Oxygen	145 (10)	5800	3/4" NPT(F) / 3/4" NPT(F)
FA33SP	Hydrogen	50 (3.4)	1250	1/4" NPT(F) / 1/4" NPT(M)
HFA43SP	Hydrogen	145 (10)	4100	3/8" NPT(F) / 3/8" NPT(F)
	Acetylene, Propane	115 (8)	900	3/8" NPT(F) / 3/8" NPT(F)



FA30PO



FA33SP



HFA43SP

Pressure Switches

Pressure switches are designed for gas manifold systems to activate remote alarm systems. Operates when cylinder/line pressure is below minimum pressure setting.



GHPS-4E
Explosion-Proof



GHPS-1
Regular

Model Number	Pressure Range psi (bar)	Max. Inlet Pressure psi (bar)	Pressure Connection
GHPS-1	5~50 (0.35~3.5)	440 (30)	1/8" NPT
GHPS-2	30~600 (2.1~41.5)	2200 (152)	1/8" NPT
GHPS-3	100~1500 (6.9~103)	2200 (152)	1/4" NPT
GHPS-4E	0.01~0.07 (1.5~10)	4.14 (600)	1/4" NPT (F)
GHPS-5E	0.1~0.52 (15~75)	4.14 (600)	1/4" NPT (F)
GHPS-6E	0.35~3.1 (51~450)	13.79 (2000)	1/4" NPT (F)

Pressure Transmitter

Model Number	Parameter
5310-B-36CP	High Pressure: 0~3600 psi, Threaded Connection: 1/4-18NPT, Electrical Connection: Din 9.4 mm, Output: 4~20mA
5310-B-300P2	Low Pressure: 0~300 psi, Threaded Connection: 1/4-18NPT, Electrical Connection: Din 9.4 mm, Output: 4~20mA



MANIFOLD COMPONENTS

Gas Filter

The gas filter is used in high pressure pipeline system to effectively eliminate the dust in the gas. Its main body is made of high quality brass and its unique structure facilitates the replacement of the filter screen.



Model Number	Gas Service	Max. Inlet Pressure psi (bar)	Inlet Connection	Outlet Connection
GF40HP	All Gases (Except Oxygen)	3000 (207)	1"-11-1/2NPS RH (F)	1"-11-1/2NPS RH (M)
GF40HPO	Oxygen	3000 (207)	1"-11-1/2NPS RH (F)	1"-11-1/2NPS RH (M)

*All gases = non-corrosive gases

Filter Elements



CF30P-03A



CF30P-03

Model Number	Gas Service	Description
CF30P-03A	Oxygen	Sintered Brass, Filtration precision: 100 µm
CF30P-03	All Gases (Except Oxygen)	Sintered Stainless Steel, Filtration precision: 30 µm

Gas Alarm Panel

GAP-02-DC24 gas alarm panel is designed to simultaneously monitor two gas supply systems. When the pressure is lower than set pressure, light-indicated and audible alarm will be triggered to inform operator to check.

- Two-input dry contact signal (electronic contact gauge or pressure switch)
- Aluminum alloy cover with compact design of 88 x 38 x 120mm
- Extra safety with external DC24V adapter power supply
- Sound and light alarm indication, adjustable alarm sound
- The audible alarm can be muted by the silence button
- When one alarm signal is alarmed and muted, the activation of the other alarm signal will not be hindered
- Built-in PCB board plug-in blocks to facilitate input and output signal lines connection
- Optional strobe light for distance sound and light alarm



GAP-02-DC24

GM100M Series LCD Alarm Systems



- 10" (25.2cm) Touch Screen Display with Password protected interface
- Provides master, area, and combination alarm signals as required by the latest edition of NFPA99
- The alarm is ETL listed to UL 1069 and CSA C22.2 No. 205 Signal Equipment
- Full networking capabilities including Modbus RTU/TCP, UDP protocols
- A Trend Log to view the pressure trends and forecast if maintenance or additional support is required
- An Event Log allows for a view history of time-stamped alarm events
- On-site customization without the use of a laptop, tablet, or mobile device

MANIFOLD COMPONENTS

Solutions for Life

Gas Terminal Box, Station Drops, Terminal Gas Control Panel

Gas Terminal Box

GSOB & GSOL Series Gas Terminals are designed for gas delivery workstations. GSOB (Box) and GSOL series (Line piping) consist of 3 types of gas outlets within a casing: direct, regulator, and flowmeter outlet. (Inlet Connection: 1/2" union).

Model Number	Gas Service	NO. of Outlet	Outlet Connection	Description
GSOB-3X	Oxygen	3	M16 X 1.5-RH (M)	Direct Type
GSOB-3Y	Athyene	3	M16 X 1.5-LH (M)	Direct Type, with Flashback Arrestor
GSOB-3F	Propane, LPG	3	M16 X 1.5-LH (M)	Direct Type, with Flashback Arrestor
GSOB-3C	Carbon Dioxide	3	M16 X 1.5-RH (M)	Direct Type
GSOB-3IN	Argon	3	M16 X 1.5-RH (M)	Direct Type
GSOB-3RX	Oxygen	3	M16 X 1.5-RH (M)	Regulator Type
GSOB-3RY	Athyene	3	M16 X 1.5-LH (M)	Regulator Type, with Flashback Arrestor
GSOB-3RF	Propane, LPG	3	M16 X 1.5-LH (M)	Regulator Type, with Flashback Arrestor
GSOB-2RX	Oxygen	2	M16 X 1.5-RH (M)	Regulator Type
GSOB-2RY	Athyene	2	M16 X 1.5-LH (M)	Regulator Type, with Flashback Arrestor
GSOB-2RF	Propane, LPG	2	M16 X 1.5-LH (M)	Regulator Type, with Flashback Arrestor
GSOB-1RX	Oxygen	1	M16 X 1.5-RH (M)	Regulator Type
GSOB-1RY	Athyene	1	M16 X 1.5-LH (M)	Regulator Type, with Flashback Arrestor
GSOB-1RF	Propane, LPG	1	M16 X 1.5-LH (M)	Regulator Type, with Flashback Arrestor
GSOB-3FC	Carbon Dioxide	3	M16 X 1.5-RH (M)	Flowmeter Type
GSOB-3FIN	Argon	3	M16 X 1.5-RH (M)	Flowmeter Type
GSOB-2FC	Carbon Dioxide	2	M16 X 1.5-RH (M)	Flowmeter Type
GSOB-2FIN	Argon	2	M16 X 1.5-RH (M)	Flowmeter Type
GSOB-1FC	Carbon Dioxide	1	M16 X 1.5-RH (M)	Flowmeter Type
GSOB-1FIN	Argon	1	M16 X 1.5-RH (M)	Flowmeter Type



GSOB-3FC (Box)



GSOB-3RF (Box)

Station Drops



GSOL-2X-R (Line Piping)

Model Number	Gas Service	NO. of Outlet	Outlet Connection
GSOL-1X-R	Argon, Carbon Dioxide, Oxygen	1	G5/8"-14RH (M)
GSOL-2X-R	Argon, Carbon Dioxide, Oxygen	2	G5/8"-14RH (M)
GSOL-1X-H	Argon, Carbon Dioxide, Oxygen	1	M16 X 1.5-RH (M)
GSOL-1F-R	Acetylene, Propane	1	G5/8"-14RH (M)
GSOL-4F-R	Acetylene, Propane	4	G5/8"-14RH (M)
GSOL-2F-H	Acetylene, Propane	2	M16 X 1.5-LH (M)
GSOL-4F-H	Acetylene, Propane	4	M16 X 1.5-LH (M)

Terminal Gas Control Panel

Model Number	Gas Service	Max. Inlet Pressure psi (bar)	Delivery PRESSURE psi (bar)	Inlet Connection	Outlet Connection
P1520F	Propane	400 (25)	0~40 (2.5)	BSP 1/4"	1/4" Hose Nipple
P1520X	Oxygen	400 (25)	0~125 (8.5)	BSP 1/4"	1/4" Hose Nipple
P1520Y	Acetylene	400 (25)	0~15 (1)	BSP 1/4"	1/4" Hose Nipple
P1520IN	Ar, He, N ₂	400 (25)	0~125 (8.5)	BSP 1/4"	1/4" Hose Nipple



P1520

MANIFOLD COMPONENTS

Flashback Arrestors, Quick Connectors & Flowmeters

Solutions for Life

Regulator Flashback Arrestors

Designed for mounting on the regulator outlet. Internal stainless steel sintered elements and check valves are constructed to provide protection from flashbacks.



FA9RF



FA9RO

Model Number	Gas Service	Working Pressure psi (bar)	Inlet Connection	Outlet Connection
FA9RF	Acetylene, Propane, LPG	22 (1.5)	9/16-18LH (F)	9/16-18LH (M)
FA9RO	Oxygen	145 (10)	9/16-18RH (F)	9/16-18RH (M)

Quick Connectors with Check Valve

Designed with a check valve to provide protection from flashbacks during gas cutting processes. The quick-opening valve at the end of the connector facilitates the connections.



RH39F



RH39X

Model Number	Gas Service	Working Pressure psi (bar)	Inlet Connection	Outlet Connection
RH36X	Oxygen	145 (10)	9/16-18RH (F)	9/16-18RH (F)
RH36F	Fuel Gas	30 (2)	9/16-18LH (F)	9/16-18LH (F)
RH39X	Oxygen	145 (10)	9/16-18RH (F)	5/16" Hose Nipple
RH39F	Fuel Gas	30 (2)	9/16-18LH (F)	5/16" Nipple

Flowmeters (Suitable for use on Piping Systems)



191FM-25L



191FM-25L-F

Series	Model Number	Gas Service	Delivery Flow (SCFH)	Mx. Inlet Pressure psi (bar)	Inlet Connection	Outlet Connection
191FM SERIES	191FM-25L	Carbon Dioxide	0-55	50 (3.5)	1/4" NPT (M)	9/16-18RH (M)
	191FM-25L	Argon	0-55	50 (3.5)	1/4" NPT (M)	9/16-18RH (M)
	191FM-25L	Helium	0-170	50 (3.5)	1/4" NPT (M)	9/16-18RH (M)
	191FM-50L	Carbon Dioxide	0-105	50 (3.5)	1/4" NPT (M)	9/16-18RH (M)
	191FM-50L	Argon	0-105	50 (3.5)	1/4" NPT (M)	9/16-18RH (M)
	191FM-50L	Helium	0-240	50 (3.5)	1/4" NPT (M)	9/16-18RH (M)
	191FM-30L	Nitrogen	0-65	50 (3.5)	1/4" NPT (M)	9/16-18RH (M)
	191FM-30L	Air	0-65	50 (3.5)	1/4" NPT (M)	9/16-18RH (M)
191FM-F SERIES	191FM-100L	Hydrogen	0-210	50 (3.5)	1/4" NPT (M)	9/16-18LH (M)
	191FM-25L-F	Carbon Dioxide	0-55	50 (3.5)	9/16-18RH (F)	9/16-18RH (M)
	191FM-25L-F	Argon	0-55	50 (3.5)	9/16-18RH (F)	9/16-18RH (M)
	191FM-25L-F	Helium	0-170	50 (3.5)	9/16-18RH (F)	9/16-18RH (M)
	191FM-50L-F	Carbon Dioxide	0-105	50 (3.5)	9/16-18RH (F)	9/16-18RH (M)
	191FM-50L-F	Argon	0-105	50 (3.5)	9/16-18RH (F)	9/16-18RH (M)
	191FM-50L-F	Helium	0-340	50 (3.5)	9/16-18RH (F)	9/16-18RH (M)
	191FM-30L-F	Nitrogen	0-65	50 (3.5)	9/16-18RH (F)	9/16-18RH (M)
191FM-30L-F	Air	0-65	50 (3.5)	9/16-18RH (F)	9/16-18RH (M)	
191FM-100L-F	Hydrogen	0-210	50 (3.5)	9/16-18RH (F)	9/16-18LH (M)	

MANIFOLD COMPONENTS

Solutions for Life

Manifold Regulators

155CG, 155M, 155TM, 153M Series Manifold Regulators



155CG



155M



155TM



153M

Series	Model Number	Gas Service	Max. Inlet Pressure psi (bar)	Delivery Pressure psi (bar)	Inlet Connection	Outlet Connection
155CG series electric heating	155CG-125-220	CO ₂	2200 (150)	4.4~120 (0.3~8.5)	1"-11-1/2"NPS RH (M)	1"-11-1/2"NPS RH (F)
	155CG-200-220		2200 (150)	10~200 (0.7~14)	1"-11-1/2"NPS RH (M)	1"-11-1/2"NPS RH (F)
155M-A series (ultra high flow system) single-stage	155MX-125-A	O ₂	2200 (150)	4.4~120 (0.3~8.5)	1"-11-1/2"NPS RH (M)	1"-11-1/2"NPS RH (F)
	155MX-200-A		2200 (150)	10~200 (0.7~14)	1"-11-1/2"NPS RH (M)	1"-11-1/2"NPS RH (F)
	155MY-15-A	C ₂ H ₂	435 (30)	1.5~14.5 (0.1~1)	1"-11-1/2"NPS LH (M)	1"-11-1/2"NPS LH (F)
	155MF-40-A	C ₃ H ₈ , LPG	435 (30)	1.5~40 (0.1~2.8)	1"-11-1/2"NPS LH (M)	1"-11-1/2"NPS LH (F)
	155MIN-125-A	Ar, He, N ₂	2200 (150)	4.4~120 (0.3~8.5)	1"-11-1/2"NPS RH (M)	1"-11-1/2"NPS RH (F)
	155MIN-200-A		2200 (150)	10~200 (0.7~14)	1"-11-1/2"NPS RH (M)	1"-11-1/2"NPS RH (F)
	155MQ-125-A	Air	2200 (150)	4.4~120 (0.3~8.5)	1"-11-1/2"NPS RH (M)	1"-11-1/2"NPS RH (F)
	155MQ-200-A		2200 (150)	10~200 (0.7~14)	1"-11-1/2"NPS RH (M)	1"-11-1/2"NPS RH (F)
	155MH-200-A	H ₂	2200 (150)	10~200 (0.7~14)	1"-11-1/2"NPS LH (M)	1"-11-1/2"NPS LH (F)
	155MC-125-A	CO ₂	2200 (150)	4.4~120 (0.3~8.5)	1"-11-1/2"NPS RH (M)	1"-11-1/2"NPS RH (F)
155MC-200-A	2200 (150)		10~200 (0.7~14)	1"-11-1/2"NPS RH (M)	1"-11-1/2"NPS RH (F)	
155TM-A series (ultra high flow system) dual-stage	155TMX-125-A	O ₂	2200 (150)	4.4~120 (0.3~8.5)	1"-11-1/2"NPS RH (M)	1"-11-1/2"NPS RH (F)
	155TMX-200-A		2200 (150)	10~200 (0.7~14)	1"-11-1/2"NPS RH (M)	1"-11-1/2"NPS RH (F)
	155TMY-15-A	C ₂ H ₂	435 (30)	1.5~14.5 (0.1~1)	1"-11-1/2"NPS LH (M)	1"-11-1/2"NPS LH (F)
	155TMF-40-A	C ₃ H ₈ , LPG	435 (30)	1.5~40 (0.1~2.8)	1"-11-1/2"NPS LH (M)	1"-11-1/2"NPS LH (F)
	155TMIN-125-A	Ar, He, N ₂	2200 (150)	4.4~120 (0.3~8.5)	1"-11-1/2"NPS RH (M)	1"-11-1/2"NPS RH (F)
	155TMIN-200-A		2200 (150)	10~200 (0.7~14)	1"-11-1/2"NPS RH (M)	1"-11-1/2"NPS RH (F)
	155TMC-125-A	CO ₂	2200 (150)	4.4~120 (0.3~8.5)	1"-11-1/2"NPS RH (M)	1"-11-1/2"NPS RH (F)
	155TMC-200-A		2200 (150)	10~200 (0.7~14)	1"-11-1/2"NPS RH (M)	1"-11-1/2"NPS RH (F)
153M-A series (ultra high flow system) single-stage	153MX-125-A	O ₂	2200 (150)	4.4~120 (0.3~8.5)	1"-11-1/2"NPS RH (M)	1"-11-1/2"NPS RH (F)
	153MX-200-A		2200 (150)	10~200 (0.7~14)	1"-11-1/2"NPS RH (M)	1"-11-1/2"NPS RH (F)
	153MY-15-A	C ₂ H ₂	435 (30)	1.5~14.5 (0.1~1)	1"-11-1/2"NPS LH (M)	1"-11-1/2"NPS LH (F)
	153MF-40-A	C ₃ H ₈ , LPG	435 (30)	1.5~40 (0.1~2.8)	1"-11-1/2"NPS LH (M)	1"-11-1/2"NPS LH (F)
	153MF-125-A	LPG	435 (30)	4.4~120 (0.3~8.5)	1"-11-1/2"NPS LH (M)	1"-11-1/2"NPS LH (F)
	153MIN-125-A	Ar, He, N ₂	2200 (150)	4.4~120 (0.3~8.5)	1"-11-1/2"NPS LH (M)	1"-11-1/2"NPS LH (F)
	153MIN-200-A		2200 (150)	10~200 (0.7~14)	1"-11-1/2"NPS RH (M)	1"-11-1/2"NPS RH (F)
	153MQ-125-A	Air	2200 (150)	4.4~120 (0.3~8.5)	1"-11-1/2"NPS RH (M)	1"-11-1/2"NPS RH (F)
	153MQ-200-A		2200 (150)	10~200 (0.7~14)	1"-11-1/2"NPS RH (M)	1"-11-1/2"NPS RH (F)
	153MH-15-A	H ₂	2200 (150)	1.5~14.5 (0.1~1)	1"-11-1/2"NPS LH (M)	1"-11-1/2"NPS LH (F)
	153MH-200-A		2200 (150)	10~200 (0.7~14)	1"-11-1/2"NPS LH (M)	1"-11-1/2"NPS LH (F)
	153MC-125-A	CO ₂	2200 (150)	4.4~120 (0.3~8.5)	1"-11-1/2"NPS LH (M)	1"-11-1/2"NPS LH (F)
	153MC-200-A		2200 (150)	10~200 (0.7~14)	1"-11-1/2"NPS RH (M)	1"-11-1/2"NPS RH (F)

MANIFOLD COMPONENTS

Manifold Regulators

Solutions for Life

591, LC853, 155HF Series Manifold Regulators



591



155HF

Series	Model Number	Gas Service	Max. Inlet Pressure psi (bar)	Delivery Pressure psi (bar)	Inlet Connection	Outlet Connection
591 series (suitable for high outlet pressure)	591X-750	O ₂	2900 (200)	4.4~125 (0.3~8.5)	G5/8"-RH (F)	Φ6
	591X-1500		2900 (200)	102~145 (7~10)	G5/8"-RH (F)	Φ6
	591X-3000		2900 (200)	200~2900 (14~200)	G5/8"-RH (F)	Φ6
	591X-3000-577		3600 (250)	200~2900 (14~200)	CGA577	Φ6
	591X-4500-701		3600 (250)	300~4350 (21~300)	CGA701	Φ6
	591IN-1500	Ar, He, N ₂	2900 (200)	100~145 (7~10)	G5/8"-RH (F)	Φ6
	591IN-3000		3600 (250)	200~2900 (14~200)	G5/8"-RH (F)	Φ6
	591IN-4500-667		5100 (350)	300~4350 (21~300)	CGA667	Φ6
	591Q-1500	Air	2900 (200)	100~145 (7~10)	G5/8"-RH (F)	Φ6
	591Q-3000		2900 (200)	200~2900 (14~200)	G5/8"-RH (F)	Φ6
	591Q-4500-680		5100 (350)	300~4350 (21~300)	CGA680	Φ6
	591H-750	H ₂	2900 (200)	50~725 (3.5~50)	W21.8-14LH	Φ6
	591H-1500		2900 (200)	100~145 (7~10)	W21.8-14LH	Φ6
591H-3000	2900 (200)		200~2900 (14~200)	W21.8-14LH	Φ6	
LC853 series (suitable for liquid vessels)	LC853X-125	O ₂	500 (35)	4.4~120 (0.3~8.5)	G3/4"-RH (F)	G3/4"-RH (F)
	LC853C-125	CO ₂	500 (35)	4.4~120 (0.3~8.5)	G3/4"-RH (F)	G3/4"-RH (F)
	LC853IN-125	Ar, N ₂	500 (35)	4.4~120 (0.3~8.5)	G3/4"-RH (F)	G3/4"-RH (F)
155HF series (suitable for high pressure and flow)	155HFX-800	O ₂	2200 (150)	50~800 (3.5~55)	G5/8"-RH (F)	M22-1.5RH (M)
	155HFIN-800	Ar, He, N ₂	2200 (150)	50~800 (3.5~55)	G5/8"-RH (F)	M22-1.5RH (M)

R66B Series Manifold Regulators

- suitable for low pressure and high flow, see details in the table below.

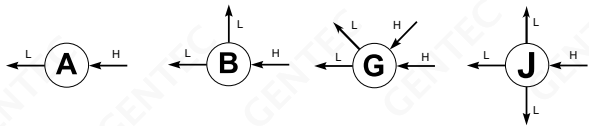

R66B	J	B	- D	Q	G	- 00	- 00
Series	Body Ports	Seat	Inlet Pressure	Outlet Pressure	Pressure Gauge	Inlet Connection	Outlet Connection
R66B (Brass)	A B G J	B: Nitrile Rubber	F: 0~500 psi	G: 0~250 psi H: 0~1250 psi I: 0~100 psi K: 0~50 psi L: 0~25 psi	W: Without pressure gauge P: with psi/bar gauge G: with Mpa gauge	06: 3/4" NPT (F) 08: 1" NPT (F) Other types of connectors are available.	06: 3/4" NPT (F) 08: 1" NPT (F) Other types of connectors are available.

MANIFOLD COMPONENTS

Solutions for Life

Station & Line Regulators

155L, 152L, 853L, 210SR, 152S, 853SR Series Station & Line Regulators

- Station & Line regulators should not be used with cylinders.
- 152L, 155L, 853L series regulators can adopt M16*1.5 inlet and outlet thread connections.

*: Adjusting T-bar can be replaced by adjusting knob for all regulators listed above.



155L



152L
(T-Bar)



152L
(Knob*)



853L

Series	Model Number	Gas Service	Max. Inlet Pressure psi (bar)	Delivery Pressure psi (bar)	Inlet Connection	Outlet Connection
155L series (high flow gas distribution system)	155LX-80	O ₂	360 (25)	2.9~80 (0.2~5.6)	3/4" NPT (F)	3/4" NPT (F)
	155LX-125		360 (25)	4.4~120 (0.3~8.5)	3/4" NPT (F)	3/4" NPT (F)
	155LX-200		360 (25)	10~200 (0.7~14)	3/4" NPT (F)	3/4" NPT (F)
	155LY-15	C ₂ H ₂	360 (25)	1.5~14.5 (0.1~1)	3/4" NPT (F)	3/4" NPT (F)
	155LF-125	C ₃ H ₈ , LPG	360 (25)	4.4~120 (0.3~8.5)	3/4" NPT (F)	3/4" NPT (F)
	155LIN-80	Ar, He, N ₂	360 (25)	2.9~80 (0.2~5.6)	3/4" NPT (F)	3/4" NPT (F)
	155LIN-125		360 (25)	4.4~120 (0.3~8.5)	3/4" NPT (F)	3/4" NPT (F)
	155LIN-200		360 (25)	10~200 (0.7~14)	3/4" NPT (F)	3/4" NPT (F)
	155LQ-80	Air	360 (25)	2.9~80 (0.2~5.6)	3/4" NPT (F)	3/4" NPT (F)
	155LQ-125		360 (25)	4.4~120 (0.3~8.5)	3/4" NPT (F)	3/4" NPT (F)
	155LQ-200		360 (25)	10~200 (0.7~14)	3/4" NPT (F)	3/4" NPT (F)
155LH-125	H ₂	360 (25)	4.4~120 (0.3~8.5)	3/4" NPT (F)	3/4" NPT (F)	
155LC-125	CO ₂	360 (25)	4.4~120 (0.3~8.5)	3/4" NPT (F)	3/4" NPT (F)	
152L series (low flow gas distribution system)	152LX-125	O ₂	360 (25)	4.4~120 (0.3~8.5)	1/4" NPT (F)	1/4" NPT (F)
	152LY-15	C ₂ H ₂	360 (25)	1.5~14.5 (0.1~1)	1/4" NPT (F)	1/4" NPT (F)
	152LF-80	C ₃ H ₈ , LPG	360 (25)	2.9~80 (0.2~5.6)	1/4" NPT (F)	1/4" NPT (F)
	152LIN-125	Ar, He, N ₂	360 (25)	4.4~120 (0.3~8.5)	1/4" NPT (F)	1/4" NPT (F)
	152LQ-125	Air	360 (25)	4.4~120 (0.3~8.5)	1/4" NPT (F)	1/4" NPT (F)
	152LH-80	H ₂	360 (25)	2.9~80 (0.2~5.6)	1/4" NPT (F)	1/4" NPT (F)
	152LC-125	CO ₂	360 (25)	4.4~120 (0.3~8.5)	1/4" NPT (F)	1/4" NPT (F)
853L series (Moderate flow gas distribution system)	853LX-125	O ₂	360 (25)	4.4~120 (0.3~8.5)	1/4" NPT (F)	1/4" NPT (F)
	853LY-15	C ₂ H ₂	360 (25)	1.5~14.5 (0.1~1)	1/4" NPT (F)	1/4" NPT (F)
	853LF-80	C ₃ H ₈ , LPG	360 (25)	2.9~80 (0.2~5.6)	1/4" NPT (F)	1/4" NPT (F)
	853LF-125		360 (25)	4.4~120 (0.3~8.5)	1/4" NPT (F)	1/4" NPT (F)
	853LIN-125	Ar, He, N ₂	360 (25)	4.4~120 (0.3~8.5)	1/4" NPT (F)	1/4" NPT (F)
	853LQ-125	Air	360 (25)	4.4~120 (0.3~8.5)	1/4" NPT (F)	1/4" NPT (F)
	853LH-80	H ₂	360 (25)	2.9~80 (0.2~5.6)	1/4" NPT (F)	1/4" NPT (F)
	853LH-125		360 (25)	4.4~120 (0.3~8.5)	1/4" NPT (F)	1/4" NPT (F)
853LC-125	CO ₂	360 (25)	4.4~120 (0.3~8.5)	1/4" NPT (F)	1/4" NPT (F)	

MANIFOLD COMPONENTS

Station & Line Regulators

Solutions for Life

210SR, 152S, 853SR Series Station & Line Regulators



210SR



152S



853SR

Series	Model Number	Gas Service	Max. Inlet Pressure psi (bar)	Delivery Pressure psi (bar)	Inlet Connection	Outlet Connection
210SR series (low flow gas distribution system) Rear input structure	210SRX-80	O ₂	200 (14)	2.9~80 (0.2~5.6)	M16-1.5RH (F)	M16-1.5RH (M)
	210SRX-125		200 (14)	4.4~120 (0.3~8.5)	M16-1.5RH (F)	M16-1.5RH (M)
	210SRY-15	C ₂ H ₂	200 (14)	1.5~14.5 (0.1~1)	M16-1.5LH (F)	M16-1.5LH (M)
	210SRF-15	C ₃ H ₈ , LPG	200 (14)	1.5~14.5 (0.1~1)	M16-1.5LH (F)	M16-1.5LH (M)
	210SRIN-80	Ar, He, N ₂	200 (14)	2.9~80 (0.2~5.6)	M16-1.5RH (F)	M16-1.5RH (M)
	210SRIN-125		200 (14)	4.4~120 (0.3~8.5)	M16-1.5RH (F)	M16-1.5RH (M)
	210SRQ-80	Air	200 (14)	2.9~80 (0.2~5.6)	M16-1.5RH (F)	M16-1.5RH (M)
	210SRQ-125		200 (14)	4.4~120 (0.3~8.5)	M16-1.5RH (F)	M16-1.5RH (M)
	210SRH-80	H ₂	200 (14)	2.9~80 (0.2~5.6)	M16-1.5LH (F)	M16-1.5LH (M)
	210SRH-125		200 (14)	4.4~120 (0.3~8.5)	M16-1.5LH (F)	M16-1.5LH (M)
210SRC-125	CO ₂	200 (14)	4.4~120 (0.3~8.5)	M16-1.5RH (F)	M16-1.5RH (M)	
152S series (Moderate and high flow gas distribution system)	152SX-40	O ₂	200 (14)	1.5~14.5 (0.1~1)	G5/8"-RH (F)	M16-1.5RH (M)
	152SX-80		200 (14)	2.9~80 (0.2~5.6)	G5/8"-RH (F)	M16-1.5RH (M)
	152SX-125		200 (14)	4.4~120 (0.3~8.5)	G5/8"-RH (F)	M16-1.5RH (M)
	152SY-15	C ₂ H ₂	200 (14)	1.5~14.5 (0.1~1)	G5/8"-LH (F)	M16-1.5LH (M)
	152SF-80	C ₃ H ₈ , LPG	200 (14)	2.9~80 (0.2~5.6)	G5/8"-LH (F)	M16-1.5LH (M)
	152SF-125		200 (14)	4.4~120 (0.3~8.5)	G5/8"-LH (F)	M16-1.5LH (M)
	152SIN-40	Ar, He, N ₂	200 (14)	1.5~14.5 (0.1~1)	G5/8"-RH (F)	M16-1.5RH (M)
	152SIN-80		200 (14)	2.9~80 (0.2~5.6)	G5/8"-RH (F)	M16-1.5RH (M)
	152SIN-125		200 (14)	4.4~120 (0.3~8.5)	G5/8"-RH (F)	M16-1.5RH (M)
	152SQ-40	Air	200 (14)	1.5~14.5 (0.1~1)	G5/8"-RH (F)	M16-1.5RH (M)
	152SH-80	H ₂	200 (14)	2.9~80 (0.2~5.6)	G5/8"-LH (F)	M16-1.5LH (M)
	152SH-125		200 (14)	4.4~120 (0.3~8.5)	G5/8"-LH (F)	M16-1.5LH (M)
	152SC-40	CO ₂	200 (14)	1.5~14.5 (0.1~1)	G5/8"-RH (F)	M16-1.5RH (M)
	152SC-80		200 (14)	2.9~80 (0.2~5.6)	G5/8"-RH (F)	M16-1.5RH (M)
152SC-125	200 (14)		4.4~120 (0.3~8.5)	G5/8"-RH (F)	M16-1.5RH (M)	
853SR series (high flow gas distribution system) Rear input structure	853SRX-80	O ₂	200 (14)	2.9~80 (0.2~5.6)	G5/8"-RH (F)	M16-1.5RH (M)
	853SRX-125		200 (14)	4.4~120 (0.3~8.5)	G5/8"-RH (F)	M16-1.5RH (M)
	853SRY-15	C ₂ H ₂	200 (14)	1.5~14.5 (0.1~1)	G5/8"-LH (F)	M16-1.5LH (M)
	853SRF-80	C ₃ H ₈ , LPG	200 (14)	2.9~80 (0.2~5.6)	G5/8"-LH (F)	M16-1.5LH (M)
	853SRF-125		200 (14)	4.4~120 (0.3~8.5)	G5/8"-LH (F)	M16-1.5LH (M)
	853SRIN-40	Ar, He, N ₂	200 (14)	1.5~14.5 (0.1~1)	G5/8"-RH (F)	M16-1.5RH (M)
	853SRIN-80		200 (14)	2.9~80 (0.2~5.6)	G5/8"-RH (F)	M16-1.5RH (M)
	853SRIN-125		200 (14)	4.4~120 (0.3~8.5)	G5/8"-RH (F)	M16-1.5RH (M)
	853SRQ-40	Air	200 (14)	1.5~14.5 (0.1~1)	G5/8"-RH (F)	M16-1.5RH (M)
	853SRQ-80		200 (14)	2.9~80 (0.2~5.6)	G5/8"-RH (F)	M16-1.5RH (M)
	853SRQ-125		200 (14)	4.4~120 (0.3~8.5)	G5/8"-RH (F)	M16-1.5RH (M)
	853SRH-80	H ₂	200 (14)	2.9~80 (0.2~5.6)	G5/8"-LH (F)	M16-1.5LH (M)
	853SRH-125		200 (14)	4.4~120 (0.3~8.5)	G5/8"-LH (F)	M16-1.5LH (M)
	853SRC-40	CO ₂	200 (14)	1.5~14.5 (0.1~1)	G5/8"-RH (F)	M16-1.5RH (M)
	853SRC-80		200 (14)	2.9~80 (0.2~5.6)	G5/8"-RH (F)	M16-1.5RH (M)
	853SRC-125		200 (14)	4.4~120 (0.3~8.5)	G5/8"-RH (F)	M16-1.5RH (M)

WARRANTY

A GENTEC® WARRANTY INFORMATION

Solutions for Life

Any GENTEC® apparatus found to be defective either in material or workmanship during the time set forth below will be replaced by Genstar Technologies Company, Incorporated or its Authorized Distributors, provided that said apparatus was used under normal conditions for the purpose intended.

Limited Warranty Period: The warranty period is as shown below, from the date of original purchase.

Product Type	Warranty from the Date of Original Purchase
Gas Manifold Systems	2 years
Pigtails	90 days

GENTEC® apparatus damaged or rendered inoperative due to abuse, negligence, misuse, accident or abnormal wear and tear is not covered by this warranty and must be repaired at the sole expense of the equipment owner. GENTEC® apparatus should be serviced or repaired by Genstar Technologies Company, Incorporated or designated service facilities only. Service or repair of this apparatus by other than Genstar Technologies Company, Incorporated or designated service facilities may void any warranties and relieve Genstar Technologies Company, Incorporated of any claims for damage and/or liability.

To make a claim under this warranty, Buyer must notify Genstar Technologies Company, Incorporated or its Authorized Distributor of the details of such claim within 30 days of discovering a defect in material or workmanship along with proof of purchase. The Buyer will be responsible for transportation costs and related risks.

Genstar Technologies Company, Incorporated shall not, under any circumstances, be liable for any damages including but not limited to: indirect, incidental, consequential, or special damages, whether such damages result from negligence, breach of warranty or otherwise.

There are no other warranties, expressed or implied, except as stated herein. This warranty gives you specific legal rights, and you may also have other rights which vary from state to state. Genstar Technologies Company, Incorporated reserves the right to discontinue manufacturing of any product or change product materials, design or specifications without notice.

WARRANTY

A GENTEC® WARRANTY INFORMATION

Solutions for Life

CRYOGENIC VESSEL

What you need to know?

- Vaporization Rate: Typically 250 to 350 SCFH.
- Outlet Pressure: Typically 125 psi, 300 psi Models are also available.
- Evaporization Rate: Up to 3% per day will vent to atmosphere.
- Temperature: Vaporizing gas is very cold. Approximately -300° Fahrenheit.

Warning: Multiple liquid cylinder manifolds MUST have the pressure building regulator of each vessel set at the same pressure to insure proper cylinder withdrawal.

HOW MANY CYLINDERS DO I NEED?

Example of argon mix manifold system at a mig welding shop:

- For a 250 CF cylinder, automatic changeover uses 230 CF and leaves 20CF in the cylinder. Manual changeover uses 250CF.
(28 CFH/Station) x 6.5 Hours/Day x 50% Duty Cycle = 91.0 CF/Day/Station
- 91.0 CF/Day/Station x 8 Welding Stations - 728 CF/Day

$$\frac{728 \text{ CF/Day}}{230 \text{ CF/Cylinder}} = 3.16 \text{ Cylinders/Day}$$

$$\frac{12 \text{ Cylinders per Header}}{3.16 \text{ Cylinders/Day}} = 3.8 \text{ Days per Header} \times 2 \text{ Headers} = \text{Maximum 7.6 Days between deliveries}$$

- Minimum Gas supply of 1 day required. Thus, in order to get gas delivered once a week (ie. every Wednesday) there will be 24 cylinders delivered every seven days in order to have uninterrupted service with an automatic manifold.



Gas Welding & Cutting Apparatus

- Gold Series Deluxe Outfits
- Cutting Outfits
- Torch Handles
- Cutting Attachments
- Hand Cutting Torches
- Machine Cutting Torches & Accessories
- Check Valves, Quick Connectors,
- Flashback Arrestors
- Welding , Heating Nozzles, Cutting Tips
- The Small Torch, The Compact Torch
- MUL-T-TORCH Outfit & Components
- Compressed Gas Regulators



HVAC & PUMING

- Air Gas Kits
- Air Gas Auto-Ignite Kits
- Air Gas Torch Handles
- Air Gas Auto-Ignite Tips
- Air Acetylene Tips
- Air Propane/MAPP® Tips
- Air Propane/MAPP® Hand Torch Kits
- Air Propane/MAPP® Hand Torch
- Oxy-Fuel Outfits
- Oxy-Fuel Apparatus
- Cutting Attachment & Tips
- The Compact Torch™ Kits
- Regulators
- Gauges



The Small Torch™ Kits

- Air-Acetylene
- Oxy-Acetylene & Oxy-Fuel Kits
- Regulators
- Replacement Hoses
- Air- Acetylene Torch Handle & Tips
- Oxy-Acetylene / Oxy-Fuel Torch Handle & Tips

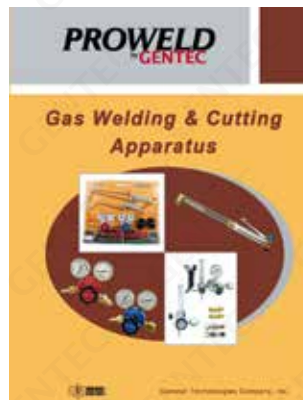

Gas Welding & Cutting Apparatus (Proweld)

- 7320, 7330 Series Duty Outfits
- 320, 330 Series Single Stage Regulators
- 394C Series Electrically Heated Regulator
- 791 Series Flowmeter Regulators
- Welding & Cutting Torches, Tips
- Flashback Arrestors, Check Valves,
- Quick Connectors
- Electrode Holders, Welding Cables
- Welding , Heating Nozzles, Cutting Tips
- Ground Clamps, Cable Connectors
- Welding Goggles, Helmets
- Strikers & Replacement Flints, Tip Cleaners
- Grade T Twin Hoses, Pressure Gauges

Please contact us for any questions about catalogs.

- Requesting Catalogs
- Register an account to view / download pdf catalogs. (Online Register)

To view our full line of Specialty Gas Products please visit us online at www.genstartech.com



Genstar Technologies Company, Inc.

4525 Edison Avenue, Chino, CA 91710, USA

Tel: 909-606-2726

Fax: 909-606-6485

www.gentec.com

